

User Manual

PCI/ PCI Express COMM Series User Manual

Industrial Serial Communication Cards

ADVANTECH

Enabling an Intelligent Planet

KOLBINGER - PCQT - +43 2239 3160

AT-2384 Breitenfurt/Vienna, Hauptstrasse 93, office@kolbinger.at , www.pcqt.at

Copyright

The documentation and the software included with this product are copyrighted 2014 by Advantech Co., Ltd. All rights are reserved. Advantech Co., Ltd. reserves the right to make improvements in the products described in this manual at any time without notice. No part of this manual may be reproduced, copied, translated or transmitted in any form or by any means without the prior written permission of Advantech Co., Ltd. Information provided in this manual is intended to be accurate and reliable. However, Advantech Co., Ltd. assumes no responsibility for its use, nor for any infringements of the rights of third parties, which may result from its use.

Acknowledgements

Intel and Pentium are trademarks of Intel Corporation.

Microsoft Windows and MS-DOS are registered trademarks of Microsoft Corp.

All other product names or trademarks are properties of their respective owners.

Product Warranty (5years)

Advantech warrants to you, the original purchaser, that each of its products will be free from defects in materials and workmanship for five years from the date of purchase.

This warranty does not apply to any products which have been repaired or altered by persons other than repair personnel authorized by Advantech, or which have been subject to misuse, abuse, accident or improper installation. Advantech assumes no liability under the terms of this warranty as a consequence of such events.

Because of Advantech's high quality-control standards and rigorous testing, most of our customers never need to use our repair service. If an Advantech product is defective, it will be repaired or replaced at no charge during the warranty period. For out-of-warranty repairs, you will be billed according to the cost of replacement materials, service time and freight. Please consult your dealer for more details.

If you think you have a defective product, follow these steps:

1. Collect all the information about the problem encountered. (For example, CPU speed, Advantech products used, other hardware and software used, etc.) Note anything abnormal and list any onscreen messages you get when the problem occurs.
2. Call your dealer and describe the problem. Please have your manual, product, and any helpful information readily available.
3. If your product is diagnosed as defective, obtain an RMA (return merchandise authorization) number from your dealer. This allows us to process your return more quickly.
4. Carefully pack the defective product, a fully-completed Repair and Replacement Order Card and a photocopy proof of purchase date (such as your sales receipt) in a shippable container. A product returned without proof of the purchase date is not eligible for warranty service.
5. Write the RMA number visibly on the outside of the package and ship it prepaid to your dealer.

Part No. 2003160000

Printed in Taiwan

Edition 1

May 2014

Declaration of Conformity

CE

This product has passed the CE test for environmental specifications when shielded cables are used for external wiring. We recommend the use of shielded cables. This kind of cable is available from Advantech. Please contact your local supplier for ordering information.

CE

This product has passed the CE test for environmental specifications. Test conditions for passing included the equipment being operated within an industrial enclosure. In order to protect the product from being damaged by ESD (Electrostatic Discharge) and EMI leakage, we strongly recommend the use of CE-compliant industrial enclosure products.

FCC Class A

This equipment has been tested and found to comply with the limits for a Class A digital device, pursuant to part 15 of the FCC Rules. These limits are designed to provide reasonable protection against harmful interference when the equipment is operated in a commercial environment. This equipment generates, uses, and can radiate radio frequency energy and, if not installed and used in accordance with the instruction manual, may cause harmful interference to radio communications. Operation of this equipment in a residential area is likely to cause harmful interference in which case the user will be required to correct the interference at his own expense.

Technical Support and Assistance

1. Visit the Advantech web site at www.advantech.com/support where you can find the latest information about the product.
2. Contact your distributor, sales representative, or Advantech's customer service center for technical support if you need additional assistance. Please have the following information ready before you call:
 - Product name and serial number
 - Description of your peripheral attachments
 - Description of your software (operating system, version, application software, etc.)
 - A complete description of the problem
 - The exact wording of any error messages

Warnings, Cautions and Notes

Warning! Warnings indicate conditions, which if not observed, can cause personal injury!



Caution! Cautions are included to help you avoid damaging hardware or losing data. e.g.



There is a danger of a new battery exploding if it is incorrectly installed. Do not attempt to recharge, force open, or heat the battery. Replace the battery only with the same or equivalent type recommended by the manufacturer. Discard used batteries according to the manufacturer's instructions.

Note! Notes provide optional additional information.



Document Feedback

To assist us in making improvements to this manual, we would welcome comments and constructive criticism. Please send all such - in writing to: support@advan-tech.com

Packing List

Before setting up the system, check that the items listed below are included and in good condition. If any item does not accord with the table, please contact your dealer immediately.

- Item XXXXXXXXX
- Box XXXXXXXXX

Safety Instructions

1. Read these safety instructions carefully.
2. Keep this User Manual for later reference.
3. Disconnect this equipment from any AC outlet before cleaning. Use a damp cloth. Do not use liquid or spray detergents for cleaning.
4. For plug-in equipment, the power outlet socket must be located near the equipment and must be easily accessible.
5. Keep this equipment away from humidity.
6. Put this equipment on a reliable surface during installation. Dropping it or letting it fall may cause damage.
7. The openings on the enclosure are for air convection. Protect the equipment from overheating. **DO NOT COVER THE OPENINGS.**
8. Make sure the voltage of the power source is correct before connecting the equipment to the power outlet.
9. Position the power cord so that people cannot step on it. Do not place anything over the power cord.
10. All cautions and warnings on the equipment should be noted.
11. If the equipment is not used for a long time, disconnect it from the power source to avoid damage by transient overvoltage.
12. Never pour any liquid into an opening. This may cause fire or electrical shock.
13. Never open the equipment. For safety reasons, the equipment should be opened only by qualified service personnel.
14. If one of the following situations arises, get the equipment checked by service personnel:
 15. The power cord or plug is damaged.
 16. Liquid has penetrated into the equipment.
 17. The equipment has been exposed to moisture.
 18. The equipment does not work well, or you cannot get it to work according to the user's manual.
 19. The equipment has been dropped and damaged.
 20. The equipment has obvious signs of breakage.
21. **DO NOT LEAVE THIS EQUIPMENT IN AN ENVIRONMENT WHERE THE STORAGE TEMPERATURE MAY GO BELOW -20° C (-4° F) OR ABOVE 60° C (140° F). THIS COULD DAMAGE THE EQUIPMENT. THE EQUIPMENT SHOULD BE IN A CONTROLLED ENVIRONMENT.**
22. **CAUTION: DANGER OF EXPLOSION IF BATTERY IS INCORRECTLY REPLACED. REPLACE ONLY WITH THE SAME OR EQUIVALENT TYPE RECOMMENDED BY THE MANUFACTURER, DISCARD USED BATTERIES ACCORDING TO THE MANUFACTURER'S INSTRUCTIONS.**
23. The sound pressure level at the operator's position according to IEC 704-1:1982 is no more than 70 dB (A).

DISCLAIMER: This set of instructions is given according to IEC 704-1. Advantech disclaims all responsibility for the accuracy of any statements contained herein.

Safety Precaution - Static Electricity

Follow these simple precautions to protect yourself from harm and the products from damage.

- To avoid electrical shock, always disconnect the power from your PC chassis before you work on it. Don't touch any components on the CPU card or other cards while the PC is on.
- Disconnect power before making any configuration changes. The sudden rush of power as you connect a jumper or install a card may damage sensitive electronic components.

Contents

Chapter 1	Introduction.....	1
1.1	Description	2
1.1.1	PCI Bus.....	2
1.1.2	PCI Express Bus.....	2
1.2	Features	2
1.3	Specifications	3
1.3.1	Bus Interface.....	3
	Table 1.1: Data Signals	4
	Table 1.2: Power Consumption	5
1.3.2	Ordering Information	6
	Table 1.3: Model List	6
	Table 1.4: PCI/ PCIe Communication Cards Selection Guide.....	7
Chapter 2	Hardware Configuration.....	9
2.1	Initial Inspection	10
2.2	Jumper and Switch Locations	11
	Figure 2.1 PCI-1601A/B Silk Screen	11
	Figure 2.2 PCI-1602 Silk Screen	11
	Figure 2.3 PCI-1602UP Silk Screen	12
	Figure 2.4 PCI-1603 Silk Screen	12
	Figure 2.5 PCI-1604UP Silk Screen	13
	Figure 2.6 PCI-1610A/B, PCI-1612A/B Silk Screen	13
	Figure 2.7 PCI-1610/1612C Silk Screen.....	14
	Figure 2.8 PCI-1620A/B Silk Screen	14
	Figure 2.9 PCI-1622B Silk Screen.....	15
	Figure 2.10PCI-1622C Silk Screen.....	15
	Figure 2.11PCIe-1620A/B Silk Screen	16
	Figure 2.12PCIe-1622A/B Silk Screen	16
2.3	Jumper Settings	17
2.3.1	How to Set Jumpers.....	17
	Figure 2.13How to Set Jumpers	17
2.3.2	Default Settings.....	17
	Table 2.1: PCI-1601/1602/1612/1622 and PCIe-1622 Settings	17
	Figure 2.14PCI-1603 Default Settings	18
2.3.3	Mode Selection by Jumper/DIP Settings	18
	Figure 2.15PCI-1612 Series RS-232/422/485 Selection	18
	Figure 2.16PCIe-1622 Series RS-232/422/485 Selection	19
	Figure 2.17RS-422/485 Selection by Jumper Setting.....	19
	Figure 2.18PCI-1603 RS-232 Mode Jumper Setting	19
	Figure 2.19PCI-1603 Current-loop Mode Jumper Setting	19
	Figure 2.20 Active Mode Jumper Setting.....	20
	Figure 2.21Passive Mode Jumper Setting	20
	Table 2.2: Enable Mode Selection.....	21
	Figure 2.22Resistor Selection (for PCI-1612/1622 series)	21
	Figure 2.23Resistor Selection (for PCI-1602 and PCIe-1622 series).....	21
2.4	Card Installation	22
Chapter 3	Driver Setup & Installation.....	23
3.1	Introduction	24
3.2	Driver Setup	24

3.2.1	Steps for Operating System Driver Setup.....	24
3.3	Driver Uninstall.....	27

Appendix 4 ICOM Tools 29

4.1	Introduction	30
4.2	Installation	30
4.3	User Interface of ICOM Tools	30
4.3.1	Menu Bar	30
4.3.2	Tool Bar	31
4.3.3	Com Port Tab	31
4.3.4	Port Status	32
4.3.5	Message Logo	32
4.3.6	Tx Slide Bar	32
4.3.7	Performance Listing Area	32
4.3.8	Status Bar	34
4.4	4.4 Using the ICOM Tools Utility.....	34
4.4.1	4.4.1 Port Selection	34
	Figure 4.1 ICOM Tools program window.....	34
	Figure 4.2 Select Port dialog box	34
	Figure 4.3 Ports You Select Will Appear in the Selected Port Checkbox Group	35
	Figure 4.4 Figure 4.4: ICOM Tools User Interface	35
4.4.2	Configuring a Port.....	36
	Figure 4.5 Test Information on the Performance Listing Area...	36
	Figure 4.6 Test Information on the Performance Listing Area...	37
4.4.3	Close Port.....	37
4.4.4	Exit the ICOM Tools utility	37
4.5	Messages on Status Bar and Message Logo Area.....	37
4.5.1	Status Bar Messages.....	37
4.5.2	Message Logo Messages.....	38

Appendix 5 Pin Assignments and Wiring 39

5.1	Pin assignments.....	40
5.1.1	PCI-1601A/B, PCI-1602.....	40
	Table 5.1: PCI-1601A/B and PCI-1602 Male DB9 on bracket...	40
5.1.2	PCI-1602UP.....	40
	Table 5.2: PCI-1602UP Male DB9 on cable.....	40
	Table 5.3: PCI-1602UP Female DB25 on bracket	41
5.1.3	PCI-1603.....	41
	Table 5.4: PCI-1603 Male DB9 on bracket.....	41
5.1.4	PCI-1604UP.....	42
	Table 5.5: PCI-1604UP Male DB9 on cable.....	42
	Table 5.6: PCI-1604UP Female DB25 on bracket	42
5.1.5	PCI-1610A/B/C	43
	Table 5.7: PCI-1610A/B/C Male DB9 on cable	43
	Table 5.8: PCI-1610A/B/C Male DB25 on cable	43
	Table 5.9: PCI-1610A/B/C Female DB37 on bracket.....	44
5.1.6	PCI-1612A/B/C	45
	Table 5.10: PCI-1612A/B/C Male DB9 on cable	45
	Table 5.11: PCI-1612A/B/C Male DB25 on cable	45
	Table 5.12: PCI-1612A/B/C Female DB37 on bracket.....	46
5.1.7	PCI-1620A/B, PCIe-1620A/B and PCIe-1622A/B.....	47
	Table 5.13: PCI-1620A/B, PCIe-1620A/B and PCIe-1622A/B Fe- male DB62 on bracket.....	47
	Table 5.15: PCI-1620A/B/C, PCIe-1620A/B, and PCIe-1622A/B Male DB25 on cable	48
	Table 5.14: PCI-1620A/B/C, PCIe-1620A/B, and PCIe-1622A/B	

	Male DB9 on cable	48
5.1.8	PCI-1622B/C.....	48
	Table 5.16: PCI-1622B/C Male DB9 on cable	48
	Table 5.17: PCI-1622B/C Female DB78 on bracket.....	49
5.2	Wiring	50
5.2.1	5.2.1 RS-232 Signal Wiring.....	50
	Table 5.18: Terminal or PC (DTE) Connections.....	50
	Table 5.19: Modem Connections.....	50
	Table 5.20: Terminal without Handshake	51
5.2.2	RS-422 Signal Wiring.....	51
	Table 5.21: RS-422 DB9 Pin Assignment	51
5.2.3	RS-485 Signal Wiring.....	52
	Figure 5.1 RS-485 Wiring Topology	52

Appendix A **Scale of Connectors** **53**

A.1	Connector Size Comparrison	54
	Figure A.1 DB9 Male.....	54
	Figure A.2 DB25 Female.....	54
	Figure A.3 DB25 Male.....	55
	Figure A.4 DB37 Female.....	55
	Figure A.5 DB62 Female.....	56

Chapter 1

Introduction

1.1 Description

1.1.1 PCI Bus

The PCI Bus is a high-performance bus that provides a processor-independent data path between the CPU and high-speed peripherals. PCI is a robust inter-connect mechanism designed specifically to accommodate multiple high performance peripherals for series communication, SCSI, LAN, etc.

Advantech serial communication card leverages the “Plug and Play” capability defined in the PCI 2.1/2.2 bus specification. The board requires only one PCI slot within the personal computer and provides independent serial channels. All channels are addressed in a continuous 32 byte I/O block for simplified software access. And, all channels may also share one PCI interrupt. An interrupt status register is available for determining the interrupt source.

The Advantech PCI communication card comes standard, containing deeper FIFOs than serial port. These upgraded FIFOs greatly reduce CPU overhead and are an ideal choice for heavy multitasking environments.

1.1.2 PCI Express Bus

The PCI Express Bus is a high-speed, scalable I/O serial bus technology that is standard designed to replace earlier PCI bus. Thus, PCI Express has numerous improvements such as higher maximum system bus throughput, less I/O pin, more detailed error detection and reporting mechanism, and smaller physical footprint. Although, at the hardware level, PCI slots and PCIe slots are not interchangeable, at the software level, PCI Express preserves compatibility with PCI device drivers and OS.

PCI Express is a point-to-point connection, which means it does not share bandwidth but communicates directly with devices via a switch that directs data flow. By adding more lanes, scalable features can be achieved for greater bandwidth.

The PCIe link between PC and other devices can consist of 1 to 32 lanes. These numbers indicate the number of lanes you wish to have. For example, PCIe x16 has 16 lanes.

1.2 Features

PCI Card Features

- PCI Specification 2.1/2.2 compliant
- Speeds up to 921.6 kbps
- UARTs with 128-byte FIFOs standard
- I/O address automatically assigned by PCI plug-and play
- Operating systems supported: 32-bit/64bit Windows 2K/Vista/XP/7, Windows CE5.0/6.0, Linux and QNX
- Optional surge protection
- Optional isolation protection for RS-232/422/485
- Interrupt status register for increased performance
- Space reserved for termination resistors
- Automatic RS-485 data flow control
- Utility-ICOM Tools

PCI Express Card Features

- PCI Express x1 compliant
- Speeds up to 921.6 kbps for extremely fast data transmission
- Supports any baud rate with high precision
- 8 x RS-232 or RS-232/422/485 ports
- Drivers for Windows 2K/Vista/XP/7, and Linux
- UARTs with 128-byte FIFO, hardware and software flow control
- Utility-ICOM Tools

1.3 Specifications

1.3.1 Bus Interface

The following table indicates models that three of bus specifications are compliant for.

■ Bus interface	■ Models
PCI bus specification 2.2	PCI-1601A/B, PCI-1602 PCI-1610A/B, PCI-1612A/B PCI-1620A/B
PCI bus specification 2.2	PCI-1602UP, PCI-1603, PCI-1604UP PCI-1610C, PCI-1612C PCI-1622C
PCI Express bus specifications 1.0	PCIe-1620A/B, PCIe-1622A/B

- **IRQ:** All ports use the same IRQ assigned by PCI/ PCIe Plug-and-Play
- **Data bits:** 5, 6, 7, 8
- **Stop bits:** 1, 1.5, 2
- **Parity:** None, Even, Odd, Mark and Space
- **Speed (bps):**

Model	Criteria	Speed (bps)
PCI-1603	RS-232	50~921.6kbps
	Current Loop	50~230.4kbps
PCI Series	X	50~230.4kbps
	A level	50~921.6kbps
	B/C level	50~230.4kbps
	UP (Low profile)	50~230.4kbps
PCI Express Series	A level	50~921.6kbps
	B level	50~230.4kbps

■ **Data Signals:**

Table 1.1: Data Signals

Bus Interface	Model Name	Ports	Current Loop	Communication Interfaces		
				RS-232	RS-422	RS-485
Universal Low-Profile PCI	PCI-1602UP	2	-	-	V **	V
	PCI-1604UP	2	-	V *	-	-
Universal PCI	PCI-1601A/B	2	-	-	V	V
	PCI-1602	2	-	-	V	V
	PCI-1603	2	V	V *	-	-
	PCI-1610A/B/C	4	-	V *	-	-
	PCI-1612A/B/C	4	-	V	V	V
	PCI-1620A/B	8	-	V	-	-
	PCIe-1622B/C	8	-	-	V	V
PCI Express	PCIe-1620A/B	8	-	V	-	-
	PCIe-1622A/B	8	-	V	V	V

1. RS-232: TxD, RxD, RTS, CTS, DTR, DSR, DCD, GND
2. RS-422: Tx+, Tx-, Rx+, Rx-, RTS+, RTS-, CTS+, CTS-
3. RS-485: Data+, Data-, GND
4. Current loop: Tx+, Tx-, Rx+, Rx-
* TxD, RxD, Rx+, Rx-, RTS+, RTS-, CTS+, CTS-, GND, RI (for PCI-1603, PCI-1604UP, PCI-1610A/ B/C_RS-232)
** TxD, RxD, Rx+, Rx-, RTS+, RTS-, CTS+, CTS-, GND (for PCI-1602UP_RS-422)

■ **Dimensions**

Size	Model
170 x 110 mm	PCIe-1620A/B, PCIe-1622A/B
185 x 100 mm	PCI-1610A/B/C, PCI-1612A/B/C, PCI-1620A/B, and PCI-1622B/C
123 x 92 mm	PCI-1601A/B, PCI-1602, and PCI-1603
119.91x 64.41mm (Low Profile PCI MD1)	PCI-1602UP, and PCI-1604UP

■ Power Consumption

Table 1.2: Power Consumption

Model	Typical	Max
PCI-1601A/B	220 mA(+5V)	270 mA(+5V)
PCI-1602	250 mA(+5V)	300 mA(+5V)
PCI-1602UP	-	300 mA(+5V)
PCI-1603	250 mA(+5V)	300 mA(+5V)
PCI-1604UP	-	300 mA(+5V)
PCI-1610A/B	60 mA(+12V) 150 mA(+5V)	80 mA(+12V) 180 mA(+5V)
PCI-1610C	-	750 mA(+5V)
PCI-1612A/B	270 mA(+5V)	338 mA(+5V)
PCI-1612C	758 mA(+5V)	803 mA(+5V)
PCI-1620A/B	114mA(+12V) 200mA(5V)	150 mA(+12V) 260 mA(+5V)
PCI-1622B	280mA(5V)	350 mA(+5V)
PCI-1622C	-	600 mA(+12V)
PCIe-1620A/B	282.66mA(+3.3V)	537 mA(+3.3V)
PCIe-1622A/B	482.66mA(+3.3V)	2057 mA(+3.3V)

- **Operating Temperature:** 0~ 65°C (32~149°F) (See IEC 68-2-1, 2),
- **Operating Humidity:** 5 ~ 95% Relative Humidity, non-condensing (IEC 68-2-3)
- **Storage Temperature:** -25 ~ 85°C (-13~185°F)
- **Current-loop Interface:** Signal Driver/receiver: 6N136/ Signals: TxD+, TxD-, RxD+, RxD-
- **Current Value:** 20mA (Standard)
- **Mode:** Asynchronous, full duplex
- **Baud-rate:** 50 ~ 921.6 kbps
- **Transmission Distance:** 1000 m

1.3.2 Ordering Information

Table 1.3: Model List

Product	Description
PCI-1601A	2-port RS-422/485 PCI Comm. Card
PCI-1601B	2-port RS-422/485 PCI Comm. Card w/Surge
PCI-1602	2-port RS-422/485 PCI Comm. Card w/Isolation
PCI-1602UP	2-port RS-422/485 Low Profile PCI Comm. Card w/Surge + Isolation
PCI-1603	2-port RS-232 PCI Comm. Card w/Isolation
PCI-1604UP	2-port RS-232 Low Profile PCI Comm. Card w/Surge + Isolation
PCI-1610A	4-port RS-232 PCI Comm. Card
PCI-1610B	4-port RS-232 PCI Comm. Card w/Surge
PCI-1610C	4-port RS-232 UPCI Comm. Card w/Surge + Isolation
PCI-1612A	4-port RS-232/422/485 PCI Comm. Card
PCI-1612B	4-port RS-232/422/485 PCI Comm. Card w/Surge
PCI-1612C	4-port RS-232/422/485 PCI Comm. Card w/Surge + Isolation
PCI-1620A	8-port RS-232 PCI Comm. Card
PCI-1620B	8-port RS-232 PCI Comm. Card w/Surge
PCI-1622B	8-port RS-422/485 PCI Comm. Card w/Surge
PCI-1622C	8-port RS-422/485 PCI Comm. Card w/Surge + Isolation
PCIe-1620A	8-port RS-232 PCI-express PCI Comm. Card
PCIe-1620B	8-port RS-232 PCI Comm. Card w/Surge
PCIe-1622A	8-port RS-232 PCI-express PCI Comm. Card
PCIe-1622B	8-port Serial PCI-express UPCI Comm. Cardw/Surge

Table 1.4: PCI/ PCIe Communication Cards Selection Guide							
Model Name	Form Factor	Ports	Comm. Interface Support	Protection Surge	Isolation		
		**All are Universal architecture.					
PCI-1601	A	-	2	RS-422/485	-	-	
	B	-			1000V _{DC}	-	
PCI-1602		-			-	2500V _{DC}	
PCI-1602UP	Low-Profile Universal				1000V _{DC}	2500V _{DC}	
PCI-1603		-			RS-232/Current Loop	-	2500V _{DC}
PCI-1604UP		Low-Profile Universal			RS-232	1000V _{DC}	2500V _{DC}
PCI-1610	A	-	4	RS-232	-	-	
	B	-			1000V _{DC}	-	
	C	-			1000V _{DC}	2500V _{DC}	
PCI-1612	A	-			RS-232/422/485	-	-
	B	-				1000V _{DC}	-
	C	-				1000V _{DC}	2500V _{DC}
PCI-1620	A	-	8	RS-232		-	-
	B	-				1000V _{DC}	-
PCI-1622	B	-		RS-422/485		1000V _{DC}	-
	C	-			1000V _{DC}	2500V _{DC}	
PCIe-1620	A	-		RS-232	-	-	
	B	-			1000V _{DC}	-	
PCIe-1622	A	-		RS-232/422/485	-	-	
	B	-			1000V _{DC}	-	

1.3.2.1 Accessories

- **OPT4A-AE:** 30cm Male DB-37 to 4xMale DB9 Cable
- **OPT8C-AE:** 1M Male DB-62 to 8xMale DB-25 Cable
- **OPT8H-AE:** 1M Male DB-62 to 8xMale DB-9 Cable
- **OPT8J-AE:** 1M Male DB-78 to 8xMale DB-9 Cable
- **OPT8HP:** 1M double shield DB-62 to 8XDB-9 Cable
- **OPT8AP-AE:** 8 port RS-232(DCE) ConnectionBox W/(F)DB25 CONN.

Chapter 2

Hardware
Configuration

2.1 Initial Inspection

1. PCI/ PCI Express Communication card
2. ICOM CD-ROM including:
 - a. User manual
 - b. Industrial Communication Driver
 - c. Utility tool

We carefully inspect our PCI/ PCI Express communication card mechanically and electrically before shipping. It should be free of marks and scratches and in perfect working condition on receipt.

As you unpack, check for any signs of shipping damage (damaged box, scratches, dents, etc.). Should any damage is found or it fail to meet specifications, please notify our service department or your local sales representative immediately. Also the carrier should be notified. Retain the shipping carton and packing material for further inspections by the carrier.

After inspection we will make arrangements to repair or replace the unit.

When you handle the communication card, remove it from its protective packaging by grasping the rear metal panel. Keep the anti-vibration packaging for further storage, as the card was removed from the PC.

Warning! *Discharge your body's static electric charge by touching the back of the grounded chassis of the system unit (metal) before handling the board. You should avoid contact with materials that hold a static charge such as plastic, vinyl and styrofoam. Handle the board only by its edges to avoid static damage to its integrated circuits. Avoid touching the exposed circuit connectors. We also recommend that you use a grounded wrist strap and place the card on a static dissipative mat whenever you work with it.*



2.2 Jumper and Switch Locations

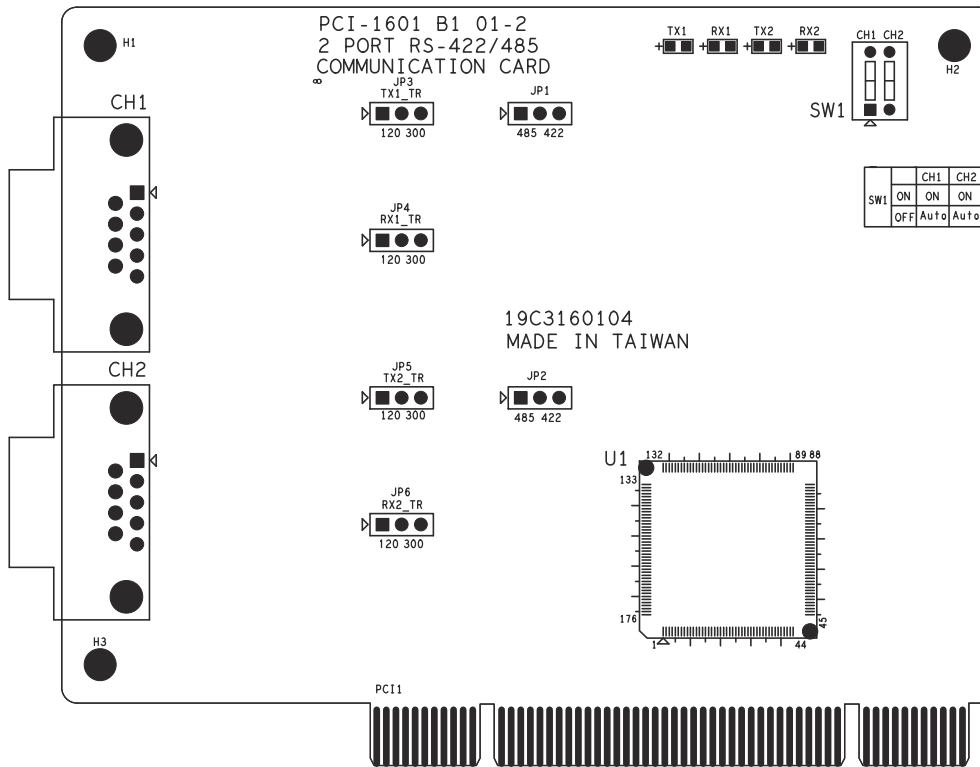

Figure 2.1 PCI-1601A/B Silk Screen

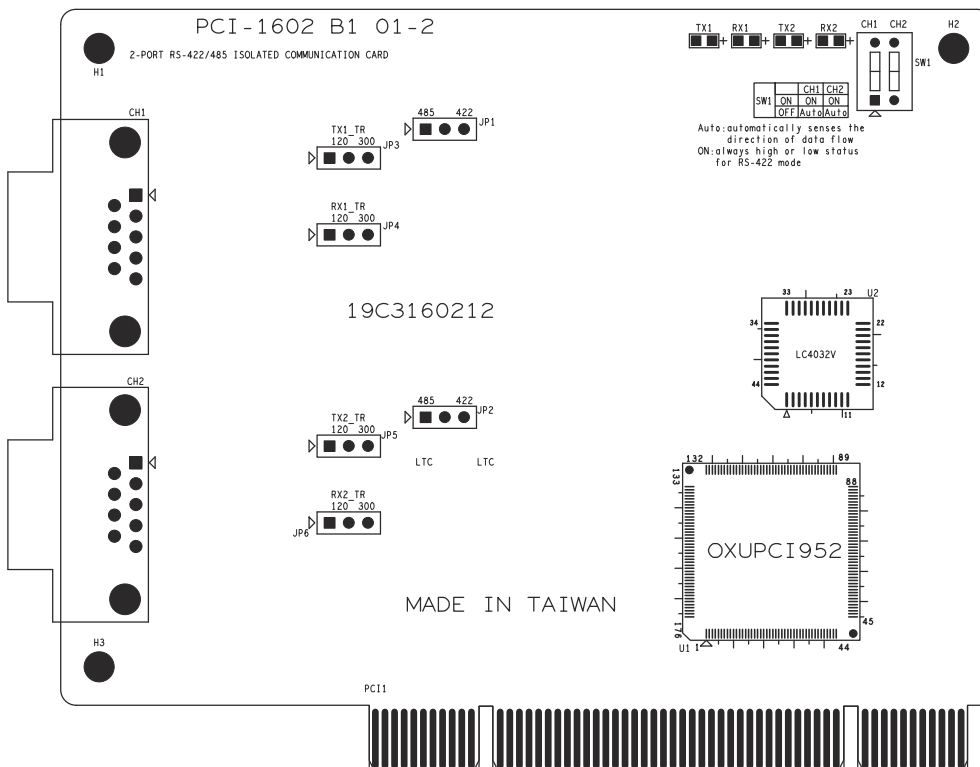

Figure 2.2 PCI-1602 Silk Screen

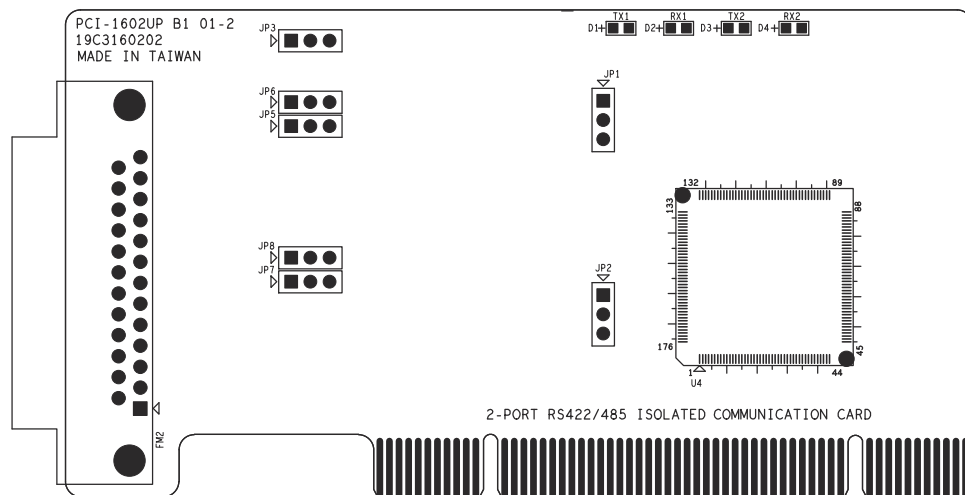

Figure 2.3 PCI-1602UP Silk Screen

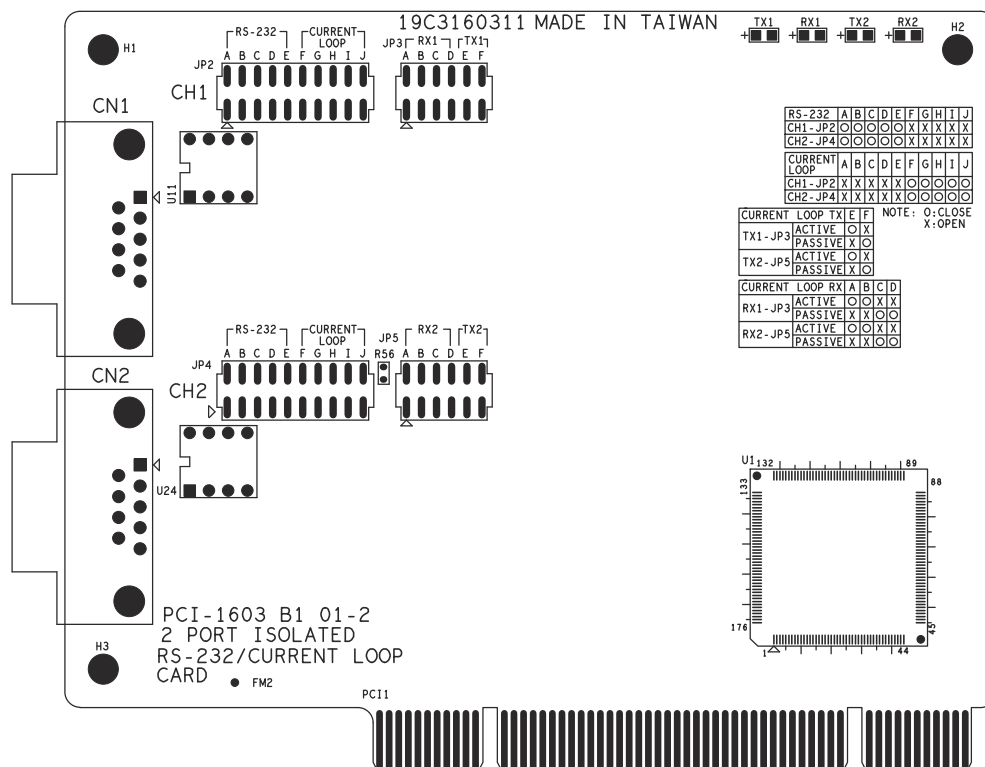

Figure 2.4 PCI-1603 Silk Screen

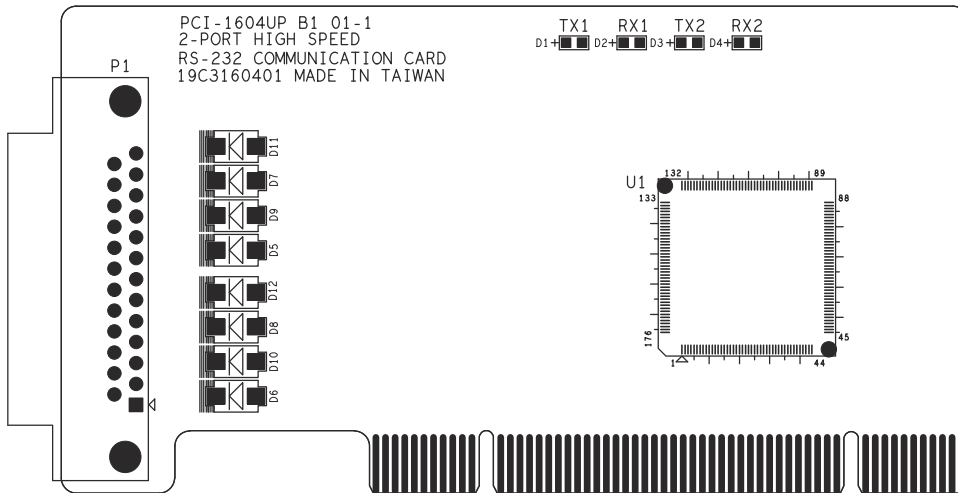

Figure 2.5 PCI-1604UP Silk Screen

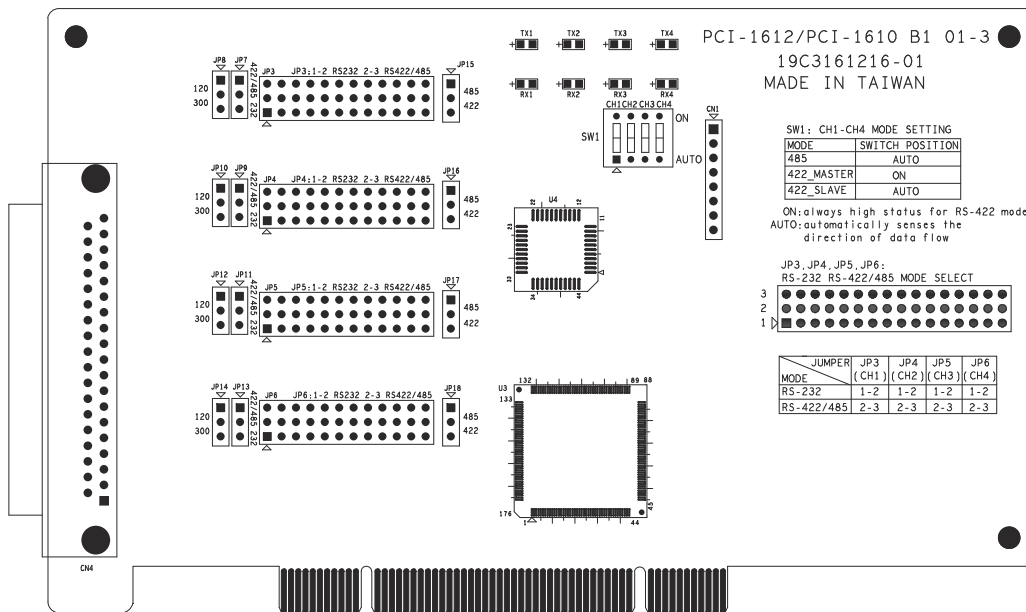

Figure 2.6 PCI-1610A/B, PCI-1612A/B Silk Screen

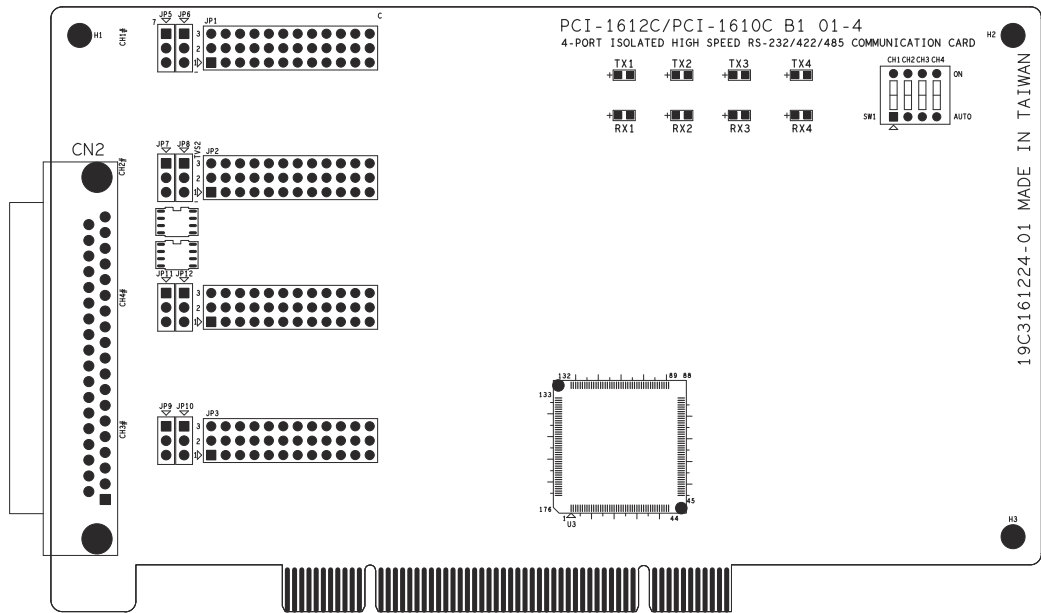

Figure 2.7 PCI-1610/1612C Silk Screen

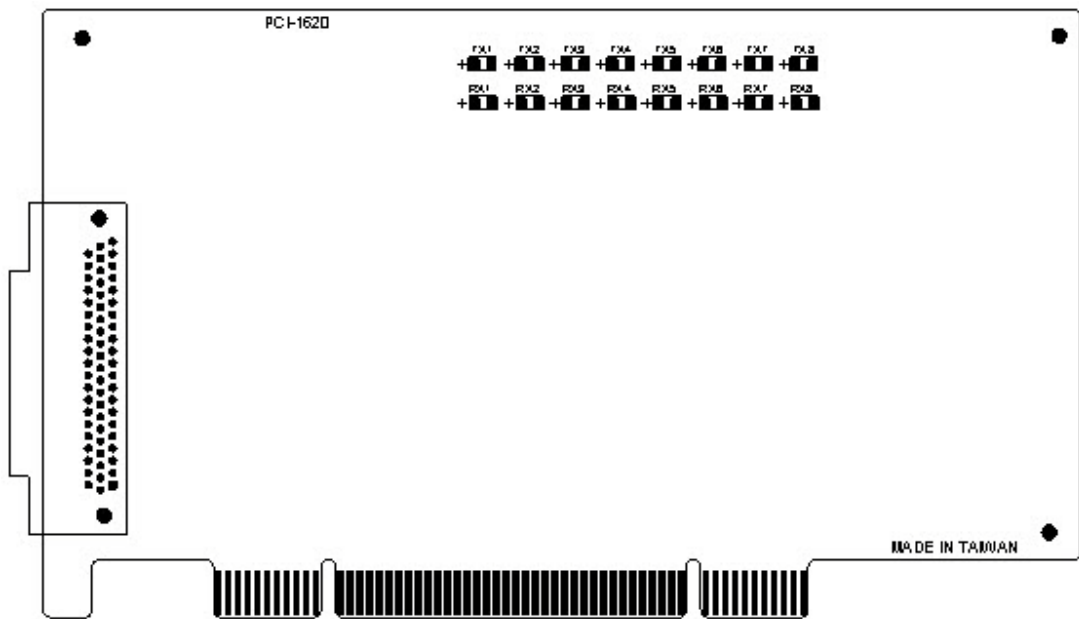

Figure 2.8 PCI-1620A/B Silk Screen

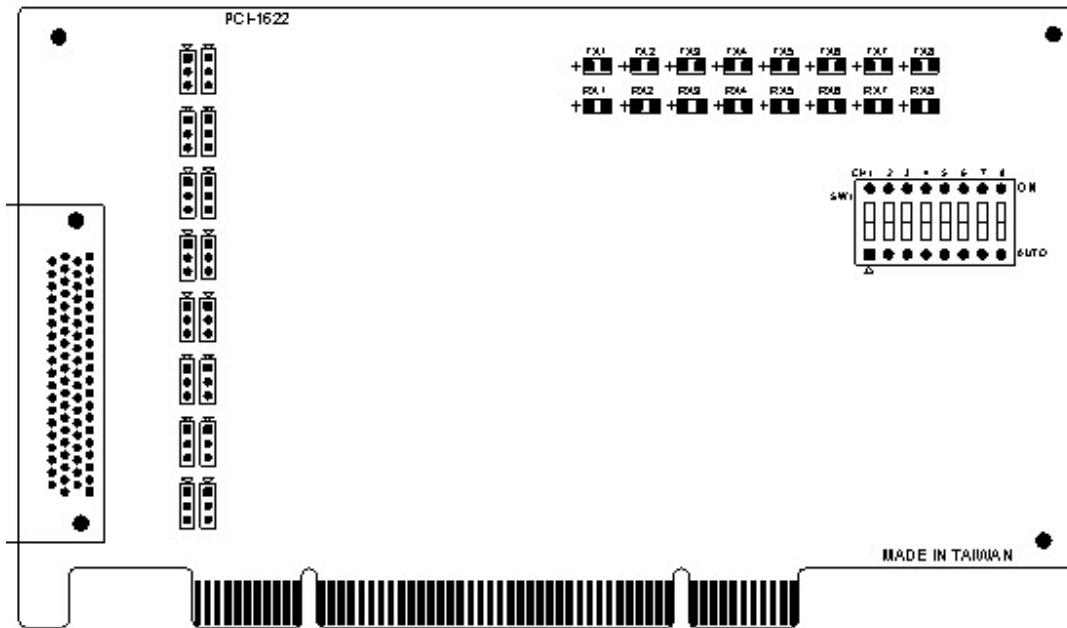

Figure 2.9 PCI-1622B Silk Screen

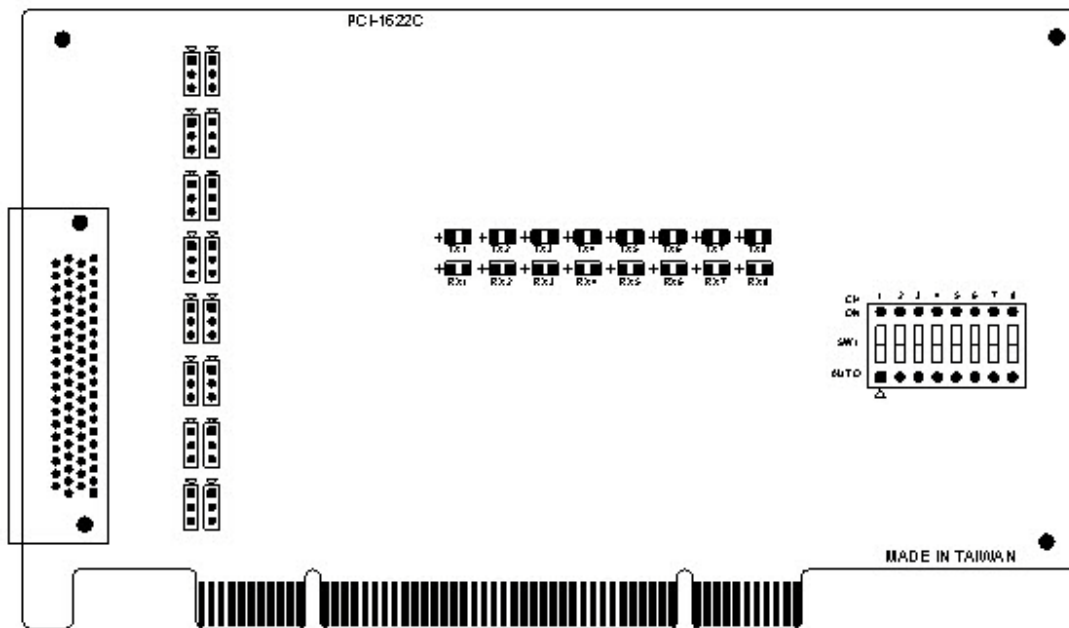

Figure 2.10 PCI-1622C Silk Screen

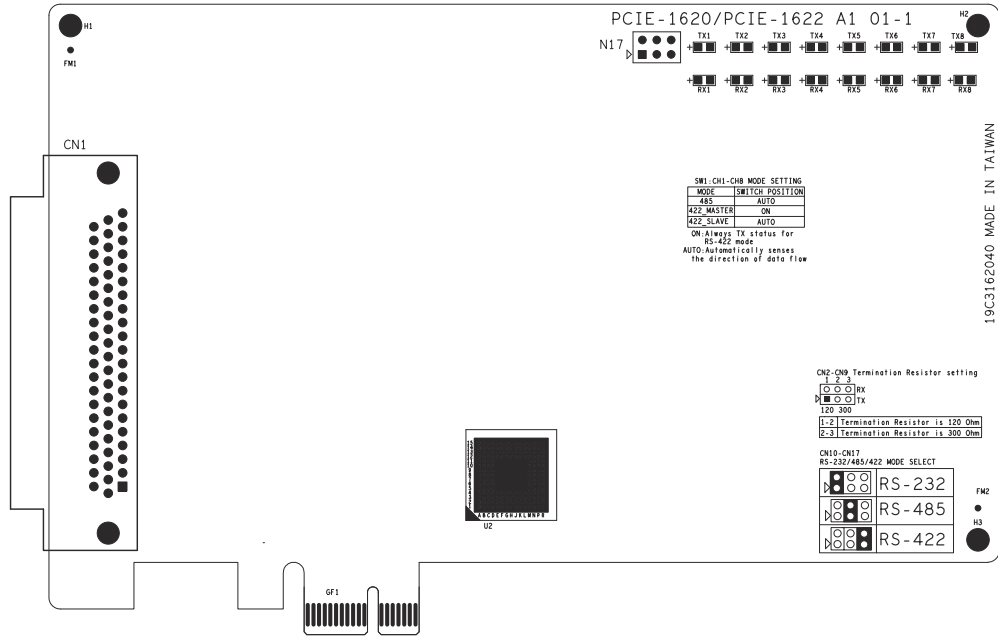

Figure 2.11 PCIe-1620A/B Silk Screen

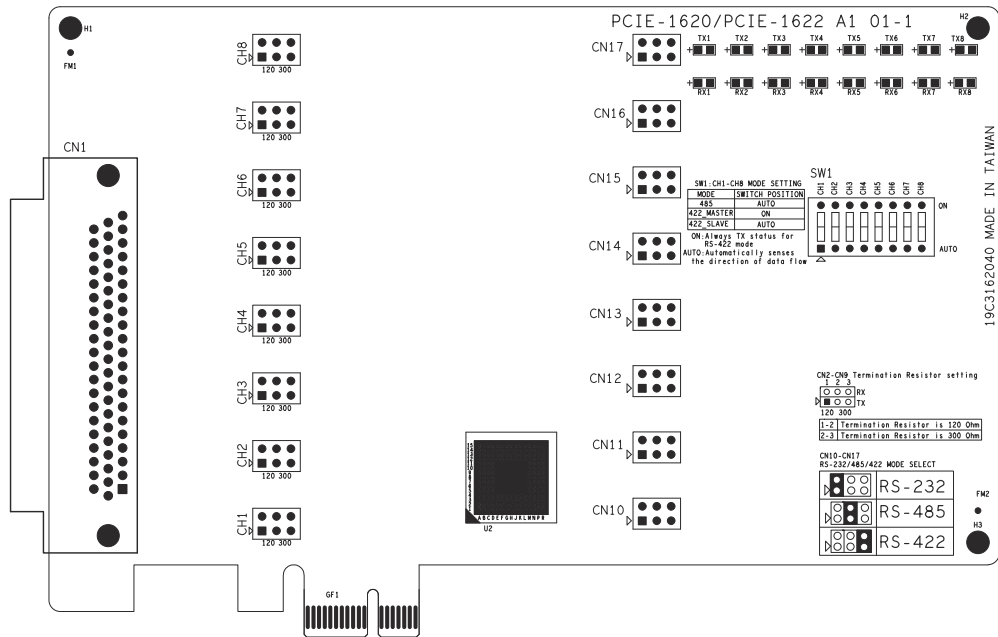

Figure 2.12 PCIe-1622A/B Silk Screen

2.3 Jumper Settings

This section tells how to set the jumpers to configure your card. It gives the card default configuration and your options for each jumper.

2.3.1 How to Set Jumpers

You configure your card to match the needs of your application by setting jumpers. A jumper is the simplest kind of electric switch. It consists of two metal pins and a small metal clip (often protected by a plastic cover) that slides over the pins to connect them. To “close” a jumper you connect the pins with the clip. To “open” a jumper you remove the clip.

Sometimes a jumper will have three pins, labeled 1, 2 and 3. In this case you would connect either pins 1 and 2 or 2 and 3.

You may find a pair of needle-nose pliers useful for setting the jumpers.

If you have any doubts about the best hardware configuration for your application, contact your local distributor or sales representative before you make any changes.

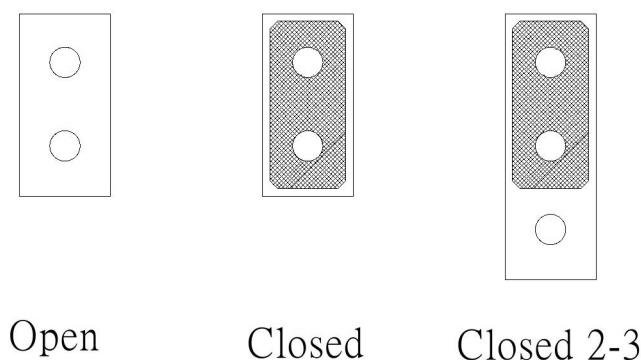

Figure 2.13 How to Set Jumpers

2.3.2 Default Settings

The board is shipped with default settings. If you need to change these settings, however, see the following sections. Otherwise, you can simply install the card.

Table 2.1: PCI-1601/1602/1612/1622 and PCIe-1622 Settings

Model	Specifications	Default Setting	Enable Mode	Remarks
PCI-1601/1602	RS-422/485	RS-422*	Auto	* means jumpers will provided for terminator use and packed in PE bag along with the card in box.
PCI-1603	RS-232/Current loop	RS-232	N/A	
PCI-1610	RS-232	RS-232	N/A	
PCI-1612	RS-232/422/485	RS-422*	Auto	
PCIe-1622	RS-232/422/485	RS-232*	Auto	

2.3.2.1 PCI-1603

The board will be shipped in the RS-232 mode, passive Rx and active Tx. On the 10*2 pin jumper groups (JP2 & JP4)— A, B, C, D and E are set to RS-232 transmission mode. On the 6*2 pin jumper groups (JP3 & JP5)—C, D and E are set to passive Rx and active Tx. They are the card default settings.

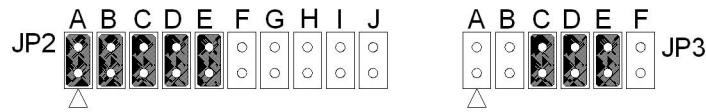

Figure 2.14 PCI-1603 Default Settings

2.3.3 Mode Selection by Jumper/DIP Settings

2.3.3.1 RS-232/422/485 Selection (for PCI-1612A/B/C)

(RS-232 Selection compatible for PCI-1610A/B/C)

Should you wish to configure the PCI-1612A/B/C to operate in the RS-232 mode, the bottom two pins of the 12*3 pin jumper should be connected. For RS-422/ RS-485 mode selection, the upper two pins of the 12*3 pin jumper should be connected, and two pins of the 13th pin jumper should be connected for only PCI-1612A/B cases, as shown below.

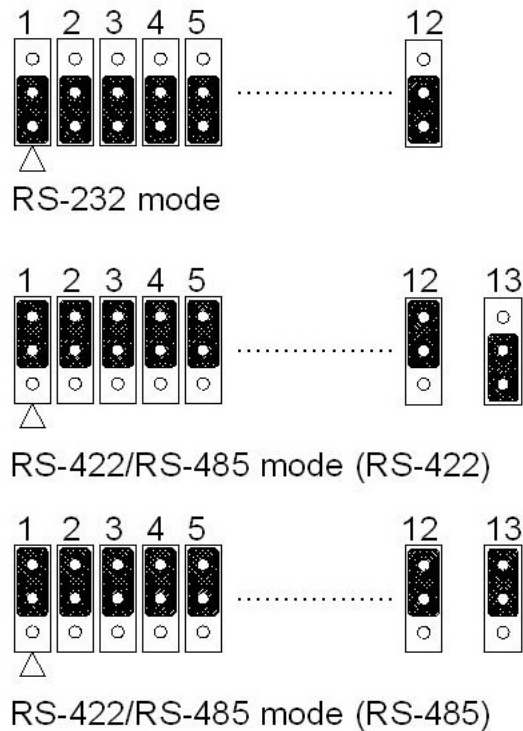

Figure 2.15 PCI-1612 Series RS-232/422/485 Selection

2.3.3.2 RS-232/422/485 Selection (for PCIe-1622A/B)

Should you wish to configure the PCIe-1622A/B to operate in the RS-232 or RS422/RS-485 mode, you will locate jumpers at CN10 to CN17 to make connection as shown below.

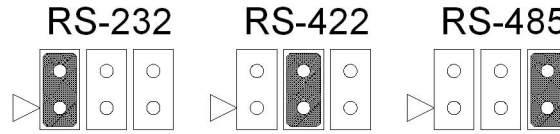

Figure 2.16 PCIe-1622 Series RS-232/422/485 Selection

2.3.3.3 RS-422/485 Selection (for PCI-1601A/B/1602/1602UP)

You can set each port individually for either RS-422 (the default) or RS-485 operation. See section 2.2 “Jumper and Switch Locations” for help to locate the jumpers.

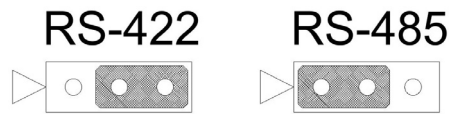

Figure 2.17 RS-422/485 Selection by Jumper Setting

2.3.3.4 PCI-1603 RS-232/Current-loop Mode Selection

For RS-232 mode operations, the jumpers will be set as the default mode. The jumpers on the 10*2 pin jumper must be set to A, B, C, D and E.

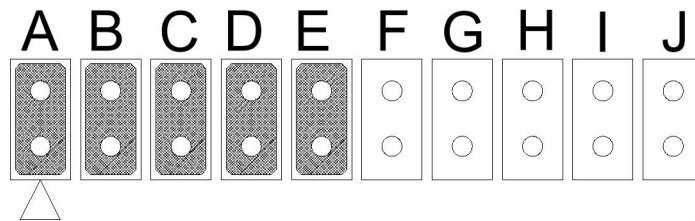

Figure 2.18 PCI-1603 RS-232 Mode Jumper Setting

To enable the channel to operate in the current-loop mode, you should set F, G, H, I and J on the 10*2 pin jumpers.

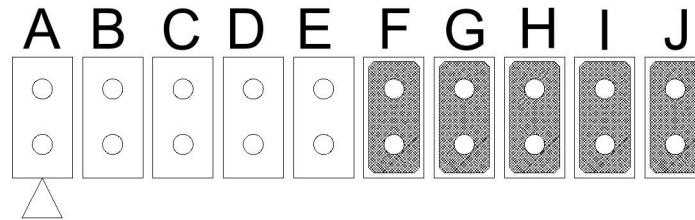

Figure 2.19 PCI-1603 Current-loop Mode Jumper Setting

Then decide which mode the Tx and Rx will operate in. The options are active or passive. In the active mode, the Tx or Rx will generate the current requirement for data transfer over the link. In the passive mode, the current is generated by the card at the other end of the link.

A and B are set to be active Rx, and E is set to be active Tx.

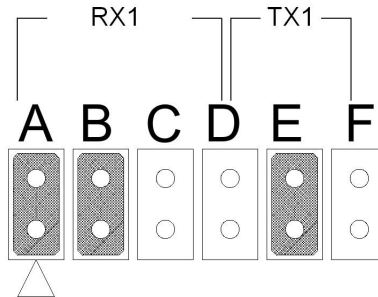

Figure 2.20 Active Mode Jumper Setting

C and D are set to be passive Rx, and F is set to be passive Tx.

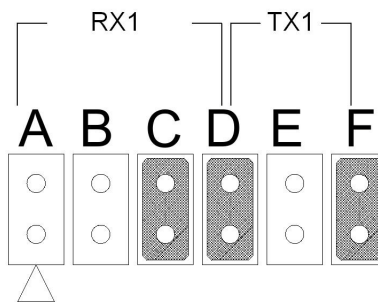

Figure 2.21 Passive Mode Jumper Setting

You may configure both Tx and Rx on one port to operate in the same mode, or you can configure each Tx and Rx on one port to operate in different modes.

If you set PCI-1603 to the current-loop mode, plug the card to your device and turn on the device, both LEDs Rx1 and Rx2 on top corner of PCI-1603 board are lightened, indicating that current-loop mode is enabled!

Note! *When either channel is configured in the RS-232 mode, the two associated Tx/Rx active/passive jumpers will be inoperable.*



2.3.3.5 Enable mode selection

You set the Enable mode using two, four or eight position DIP switches, one for each port. If the switches are set to "AUTO", the driver automatically senses the direction of the data flow and switches the direction of transmission. No handshaking is necessary.

If DIP switches are set to "On", the driver is always enabled, and always in high or low status. The user must select a mode before beginning RS-422 applications.

Table 2.2: Enable Mode Selection

Mode	Switch Position
RS-485	AUTO
RS-422_Master	ON
MS-422_Slave	AUTO

2.3.3.6 Terminator setup (for PCI-1601/1602/1612/1622)

You can install terminator resistors if necessary to match impedance. Each signal line (Tx, Rx) has a separate resistor.

Especially in fields with serious electric noise, installing terminal resistors is helpful to stabilize communications. Make sure that both sides of the RS-485 communication ports are installed on BUS. See details in Chapter 5.2.2 and 5.2.3.

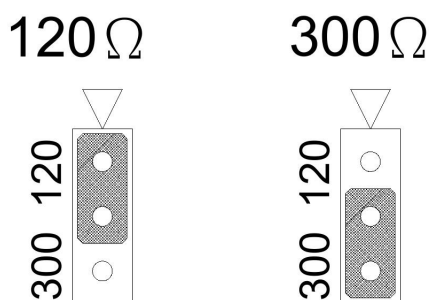

Figure 2.22 Resistor Selection (for PCI-1612/1622 series)

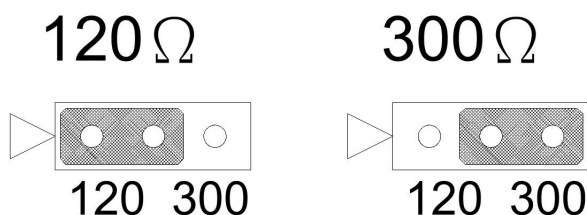

Figure 2.23 Resistor Selection (for PCI-1602 and PCIe-1622 series)

2.4 Card Installation

Note! *We strongly recommend that you install the software driver before you install the hardware into your system, since this will guarantee a smooth and trouble-free installation process.*



Turn off your PC's power supply whenever you install or remove the PCI/PCIe communication card or its cables. Static electricity can easily damage computer equipment. Ground yourself by touching the chassis of the computer (metal) before you touch any boards. See the static warning on Ch.2

1. Install the driver; see chapter 3.1 and chapter 3.2.
2. Turn off the computer and all peripheral devices (such as printers and monitors).
3. Disconnect the power cord and any other cables from the back of the computer.
4. Remove the PC's cover (refer to your user's guide if necessary).
5. Install and plug the PCI/PCIe communication card on your PCI/PCIe BUS.
6. Replace the PC's cover. Connect the cables you removed in step 3.
7. Turn the computer power on.
8. Driver will install PCI/PCIe Communication card automatically, see chapter 3.3 and 3.4 and 3.5.
9. Test your COM port and verify if COM port could work normally, see chapter 4.
10. Refer to the pin assignment and cabling for further information, see chapter 5.

Chapter 3

Driver Setup &
Installation

3.1 Introduction

This chapter describes the driver installation, configuration and removal procedures for the for the afore mentioned Windows operating system. We strongly recommend that you install the software driver before you install the hardware into your system, since this will guarantee a smooth and trouble-free installation process.

3.2 Driver Setup

Windows operating system supports COM1 to COM256, meaning up to 256 serial ports. In order to fully utilize the advanced features of Windows operating system, such as multiprocess and multithread, pure 32-bit Windows 2K/XP/Vista/7 and others, as afore indicated, device drivers are provided for the PCI/PCIe communication cards. All these drivers conform to the Win32 COMM API standard.

3.2.1 Steps for Operating System Driver Setup

Before you install the card into your system, we recommend you install the driver first. Follow the steps below for the PCI/PCIe communication cards' windows operating system driver installation.

1. Insert your companion DVD-ROM disc into your DVD-ROM drive.
2. The driver setup program will be launched automatically. If the auto-play function is not enabled on your system, use Windows Explorer or the Windows Run command to execute autorun.exe on the companion DVD-ROM.

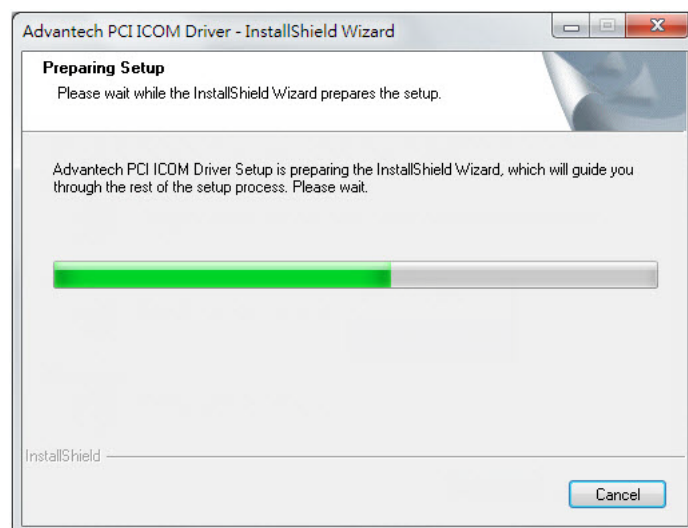

3. After the setup program is launched, you'll see the following Screen.



4. Click the Continue button and the catalogue select page appears. Then click the **Installation** button for installation.



5. Choose the driver you want to install, then click the hyperlink.

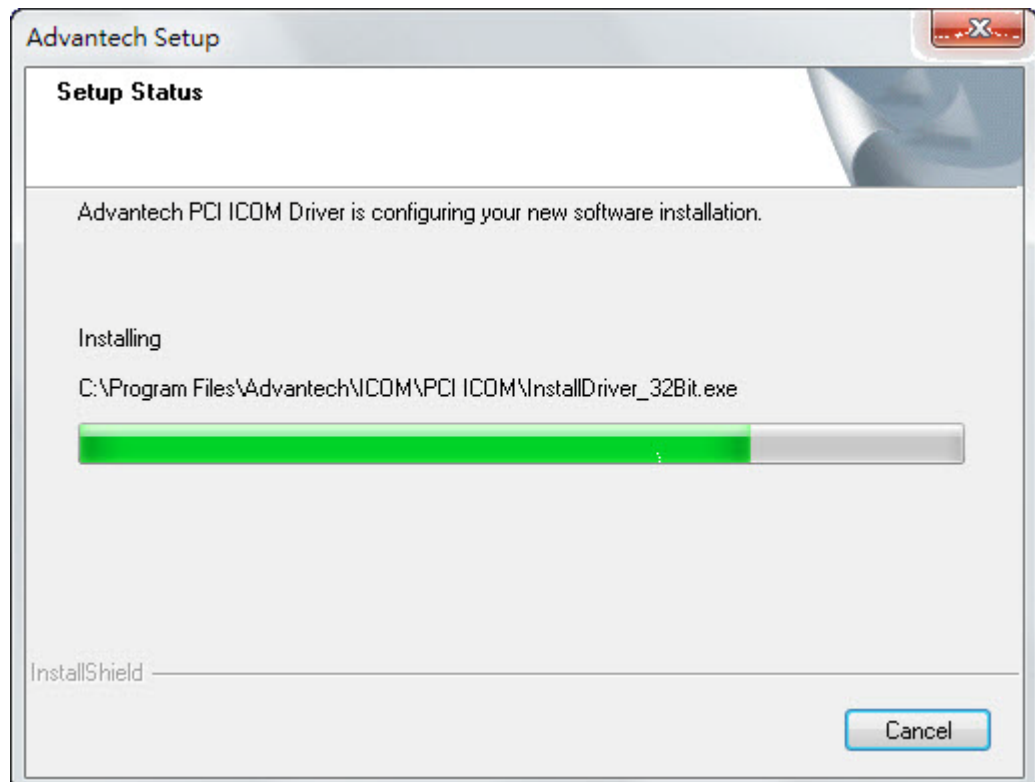
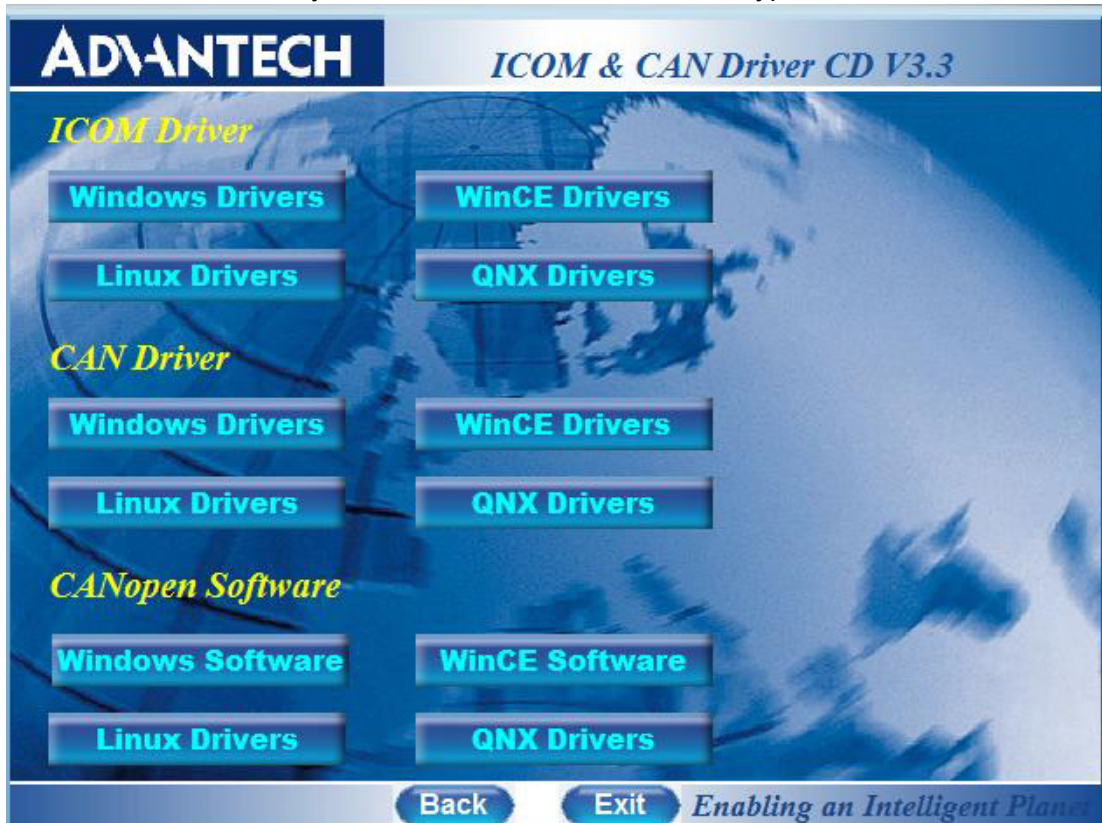

3.3 Driver Uninstall

1. Insert the ICOM DVD and click the driver you want to uninstall.

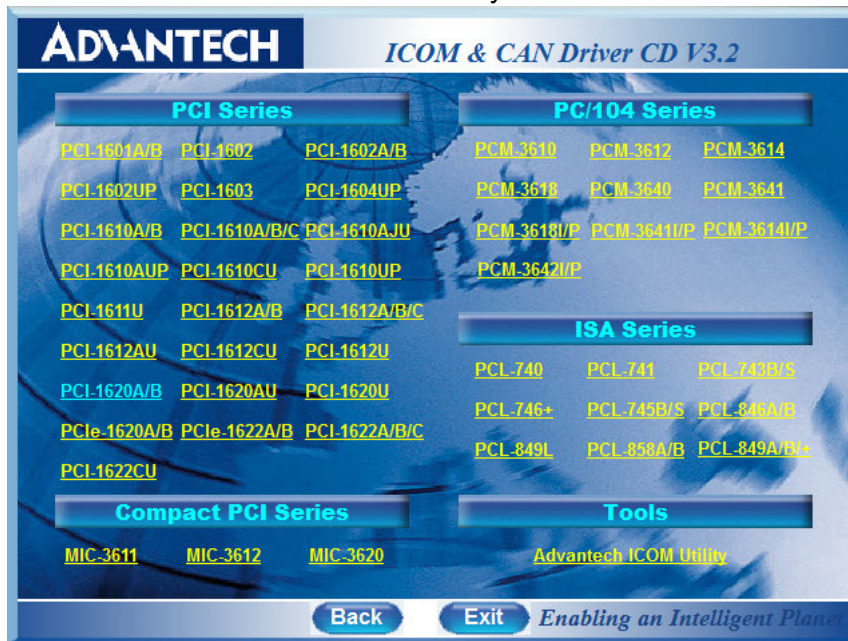

2. Choose “**Modify**” radio button if you want to save another driver. Or choose “**Remove**” radio button to remove all installed components.

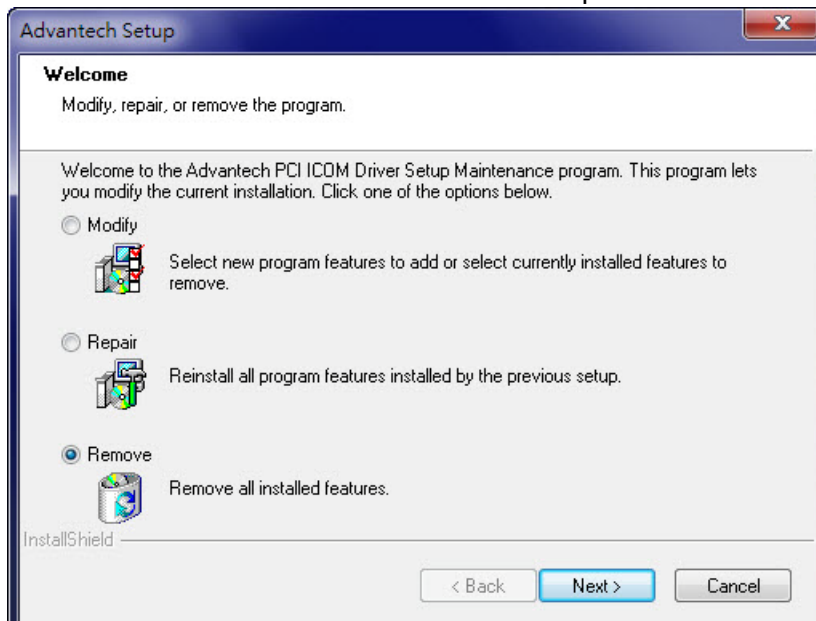

Chapter 4

ICOM Tools

4.1 Introduction

Advantech ICOM Tools is a convenient utility that has been designed to help you test the performance of ICOM cards through analyzing the port status. It features an easy to use graphical user interface that will soon make you familiar with testing via menu commands and toolbar buttons.

Advantech ICOM Tools is applicable to all series of Advantech ICOM cards, and can even be used with other third-party ICOM cards. It is included for free on the diskette or on the companion DVD-ROM with all Advantech Industrial Communication cards.

4.2 Installation

To begin installation, double-click the ICOM_Tools.exe program icon in the Tools folder or click the Advantech ICOM Utility hyperlink in the installation window to launch the ICOM Tools setup program. The setup program will copy the program files to the destination folder you choose or to the default installation path (i.e. C:\Program Files\Advantech\ICOM Tools). A program folder will be created in your Start/Programs menu. (Later you can just access the program through Start/Program/Advantech PCI Comm Tools/COM Examine Tool)

4.3 User Interface of ICOM Tools

4.3.1 Menu Bar

Port All Ports Help

On the Menu Bar you can select various menu commands to perform port-testing functions. You can also use the short-cut keys.

Port Submenu

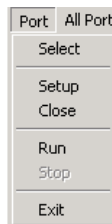

Select: Select the ports you want to configure

Setup: Setup the configuration of a specific port

Close: Close a specific port

Run: Run the test on a specific port

Stop: Stop the test on a specific port

All Ports Submenu



Setup: Setup the configurations of all ports

Run: Run the test on all ports









Stop: Stop the test on all ports

Help Submenu Access Online help

4.3.2 Tool Bar



Using the Tool Bar buttons is a more intuitive way to implement the functions of ICOM Tools.

	Port Select: Selects the port(s) you want to perform testing on
	Port Setup: Sets up configuration of the port you have selected
	Port Close: Closes the port you have selected
	Port Run: Runs the port test on the port you have selected
	Port Stop: Stops the port test on the port you have selected
	All Ports Setup: Sets up the configuration of all ports not running test
	All Ports Run: Runs test on all ports
	All Ports Stop: Stops test on all ports
	Clear Message: Clears messages on Message Logo area and the Rx length information on the Performance Listing area

4.3.3 Com Port Tab

Each Com Port tab represents a specific port you have selected for test and configuration. On the tab, you can see the Transfer Mode, Port Status, and Message Logo area.

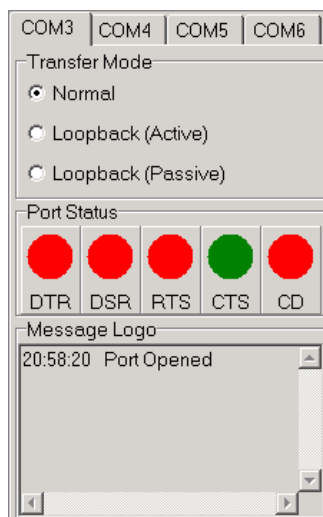

Transfer Modes

You can specify the transfer mode to be Normal, loopback (active) or loopback (passive).

Normal—allows data to be transmitted and received simultaneously. The data reception rate is helpful in identifying the performance of a communication card installed on your system.

Loopback- In loopback mode a series of special data will be transmitted, which are expected to appear on the receiving end. Using the loopback mode, you can check the integrity of received data and find whether any error occurred on the transmission line. The active loopback and passive loopback must work in pair to enable the loopback mode. When a port operates as active loopback mode, it will send data first and

receive data later. Another port, which operates as passive loopback, will retransmit any received data on the Rx line and then send these data onto the Tx line. These two modes will form a logical loop and help to verify the integrity of data transmitted over the communication link.

4.3.4 Port Status

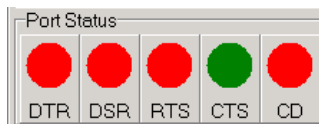

DTR (data-terminal-ready)

DSR (data-set-ready)

RTS (request-to-send)

CTS (clear-to-send)

CD (carrier-detect)

For RS-232 specifications, DTR and RTS are for output signals and can be toggled on and off by double-clicking the labels (such as DTR, DSR, RTS, CTS, CD) under the red/green marks. However, if you are using RTS/CTS for flow control to run the test, you will see the RTS mark appear in black. This indicates that the RTS can no longer be toggled on/ off since it is controlled by driver itself.



A black mark represents that the function is controlled by the driver itself and therefore not controllable by software.

4.3.5 Message Logo

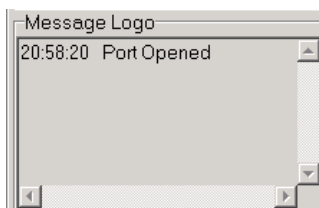

On the Message Logo area, you can see the relevant messages about the port(s) you have selected.

For information about specific messages in this area, please refer to Section 4.5, Messages on the Status Bar and Message Logo area.

4.3.6 Tx Slide Bar

The Tx Slide Bar allows you to control the overall system loading. You can adjust the transmission rate of your port(s) from 0% to 100%. Just drag the slide button along the track to adjust the transmission rate.



4.3.7 Performance Listing Area

On the performance listing area, you can see the relevant information, such as Rx Length (received packet byte length), Bytes/Sec (transmission rate) and Last Abnormal Status of each port running a test.

The image shows a window titled "Performance" containing a table with four columns: "Port", "Rx Length", "(Bytes/Sec)", and "Last Abnormal Status". The table is currently empty.

Port	Rx Length	(Bytes/Sec)	Last Abnormal Status
------	-----------	-------------	----------------------

4.3.8 Status Bar

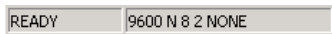

The Status Bar is where you can glimpse the current information of the port you have selected. The Status Bar indicates whether the port is READY, RUNNING, BUSY or STOPPED, N/A PORT and the configuration information such as baud rate, data bit, stop bit, parity bit and flow control (represented as 1200 N 8 1 None) settings. Also we can see the duration of the test in hh:mm:ss format on the right.

For information about specific messages on this area, please refer to Section 4.5, Messages on the Status Bar and Message Logo area.

4.4 4.4 Using the ICOM Tools Utility

To launch the ICOM Tools testing utility, access Start/Programs/Advantech PCI Comm Tools/COM Examine Tools to start the port testing utility.

4.4.1 4.4.1 Port Selection

Follow the steps below to make your port selection:

1. Launch ICOM Tools. You will first see the Program Window such as Figure 4.1. Since you haven't selected any port for testing yet, all you can see now is a blank window area.



Figure 4.1 ICOM Tools program window

2. Select the port(s) you want to test by the Port/Select menu command or by clicking the Port Select button on the Toolbar, and a dialog box such as Fig. 2 will appear.

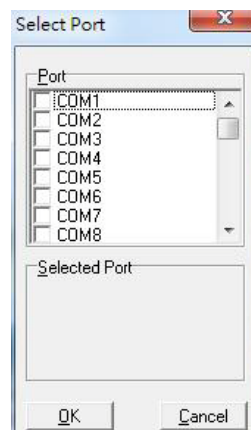

Figure 4.2 Select Port dialog box

Select the port(s) you want to perform test on from the checkboxes next to each COM port. You can either click the checkbox or double-click the name(s) of the port(s) to select/deselect port(s) to perform the test on. The port(s) you selected will immediately appear in the Selected Port field.

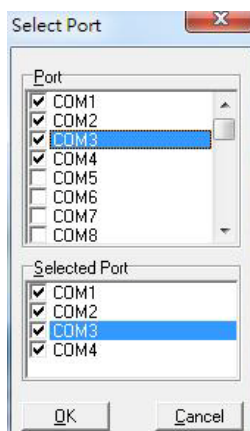

Figure 4.3 Ports You Select Will Appear in the Selected Port Checkbox Group
Click OK to bring up the ICOM Tools User Interface such as below:

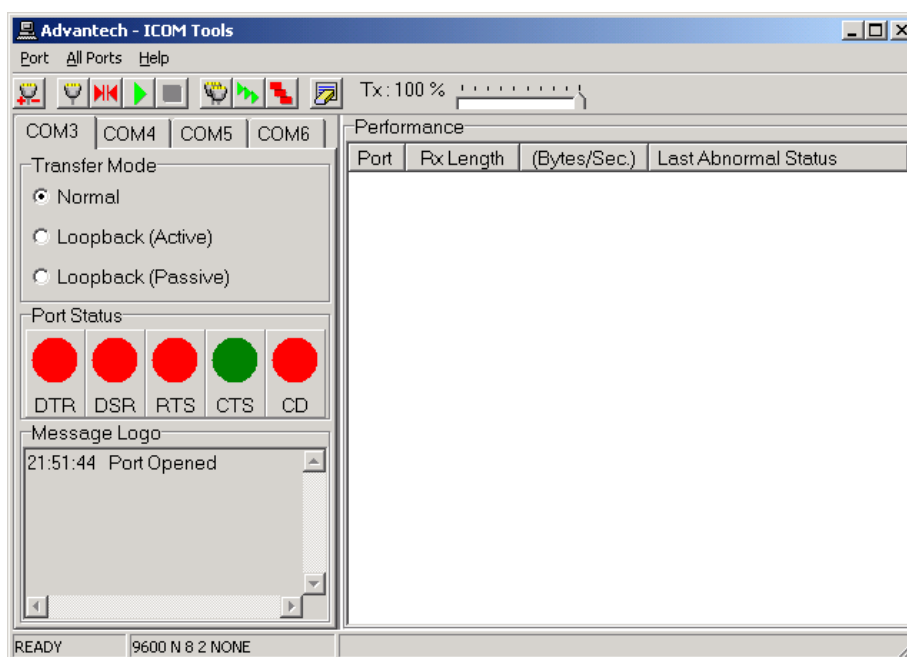



Figure 4.4 Figure 4.4: ICOM Tools User Interface

4.4.2 Configuring a Port

You can choose to configure a specific port (or to configure all ports) before running your test. Just click a Com Port Tab to select the port you want to configure, and then click the **Port Setup**  button or use the **Port/Setup** menu command (or if you want to configure all ports at once, just click the **All Ports Setup**  button or access the All Ports/Setup menu command) to bring up the Configure Port dialog box such as below.

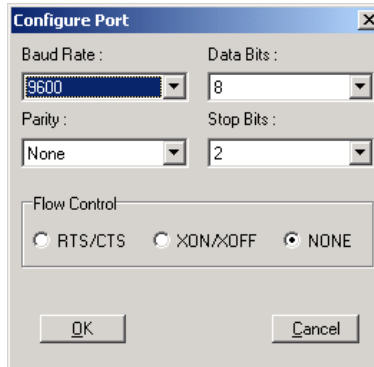



Figure 4.5 Test Information on the Performance Listing Area



In the **Configure Port** dialog box, you can configure the Baud Rate, Data bits, Parity, Stop Bits and the flow control mode for that specific port (or for all ports). After you have configured all the settings you want to change, click **OK** to make this configuration active.

Note!



*When using **All Ports Setup** button or **All Ports/ Setup**  menu command to configure settings for all ports, you must take care to stop any ports that are running test in order to configure them. If you do not stop the test running on a specific port, it won't be configured at all. That is, you get to configure only the ports that have been stopped.*

Run the Test

After you have completed the configuration of the port(s), you can now start the test on the port you have selected by clicking the **Run**  button or accessing the **Port/Run** menu command (or you want to run all ports at once, just click the **All Ports Run**  button or access **All Ports/Run** menu command).

Once the test is started, you can see relevant test information of port performance on the **performance listing area**.

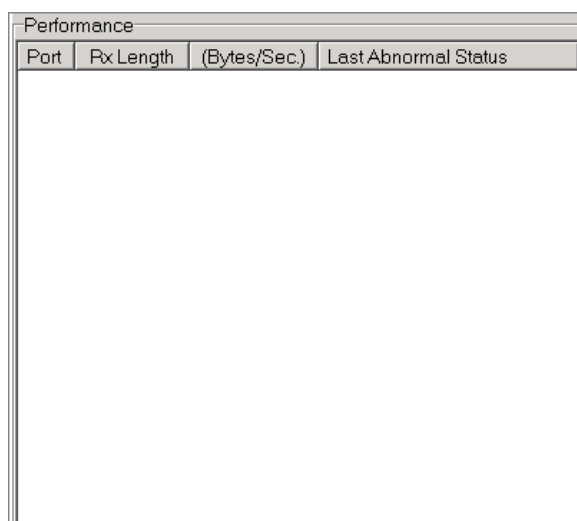





Figure 4.6 Test Information on the Performance Listing Area

The Performance Listing Area

Port	The com port number
Rx length	Received packet length in bytes
Bytes/Sec	Transmission rate in Bytes/Sec
Last Abnormal Status	Last abnormal status

Stop the Test

If you want to stop the test on a specific port, just click **Port Stop**  button or access **Port/Stop** menu command (or if you want to stop test on all ports, just click **All Ports Stop**  button or access All Ports/Stop menu command).

You can restart the test by clicking the **Run**  button or accessing the Port/Run menu command (or if you want to run all ports at once, just click the **All Ports Run**  button or access All Ports/Run menu command).

4.4.3 Close Port

If you want to close a port, just select the **Com Port** tab and click **Port Close** button or access **Port/Close** menu command to close the port.

4.4.4 Exit the ICOM Tools utility

To exit the ICOM Tools utility, simply access Port/Exit menu command or click the Close button on the upper right corner of the program window.

4.5 Messages on Status Bar and Message Logo Area

Messages appearing on the Status Bar and Message Logo area are helpful in understanding specific information of your system settings and performance.

4.5.1 Status Bar Messages

BUSY: the port is currently used by another application.

FAIL: the configuration parameters are not accepted by the port

N/A PORT: the port is not available in the system

READY: the port is ready to run or to be configured.

RUNNING: the test is running on the port

STOPPED: the test running on the port has been stopped by the user

4.5.2 Message Logo Messages

Port Opened: The user has opened the port

Port Setup Fail: The user has set up the port configuration with parameters that are either incorrect or unsupported.

Port Running: The port is running a test

Port Stopped: The test is stopped on the port

Tx Starting/Tx Stopped: Transmitting starting/transmitting stop

Rx Starting/Rx Stopped: Receiving starting/receiving stop

Break Error: A break event has been detected on the port

Framing Error: A timing error (i.e. from start bit to stop bit) has been detected on the port

Port I/O Error: An incorrect I/O event has been detected on the port

Rx Overrun: Received data has been overwritten before being processed

Rx Buffer Full Error: The buffer on the receiving end is saturated so that newly arrived data are ignored

Tx Buffer Full Error: The buffer on the transmitting end is saturated so that the data transmitted by applications are ignored.

LB Error - %d: Data error is detected in loop back

LB Rx Pending: Loop back mode is waiting for incoming data

Data Setup Error: Parameter error in port configuration

Chapter 5

Pin Assignments and
Wiring

5.1 Pin assignments

5.1.1 PCI-1601A/B, PCI-1602

The following table and figure shows the pin assignments of two male DB9 connectors on the bracket for PCI-1601A/B and PCI-1602 cards in RS-422 and RS-485 modes.

Table 5.1: PCI-1601A/B and PCI-1602 Male DB9 on bracket

Pin	RS-422	RS-485
1	Tx-	Data-
2	Tx+	Data+
3	Rx+	-
4	Rx-	-
5	GND	GND
6	RTS-	-
7	RTS+	-
8	CTS+	-
9	CTS-	-

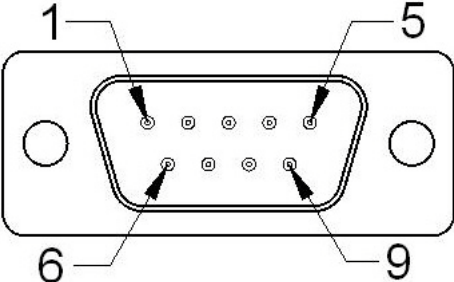

5.1.2 PCI-1602UP

The following tables and figures show the pin assignments of 1 female DB25 connector on the bracket to two male DB9 for PCI-1602UP card in RS-422 and RS-485 modes.

Table 5.2: PCI-1602UP Male DB9 on cable

Pin	RS-422	RS-485
1	Tx-	Data-
2	Tx+	Data+
3	Rx+	-
4	Rx-	-
5	GND	GND
6	RTS-	-
7	RTS+	-
8	CTS+	-
9	CTS-	-

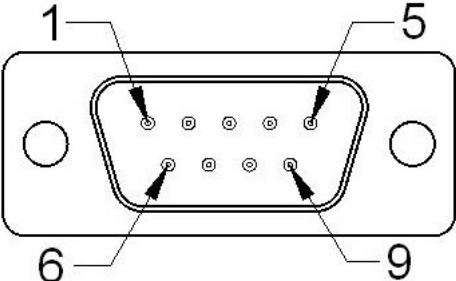

Table 5.3: PCI-1602UP Female DB25 on bracket					
Pin	RS-422	RS-485	Pin	RS-422	RS-485
1	2_Tx-	2_Data-	14	2_RTS-	-
2	2_Tx+	2_Data+	15	2_RTS+	-
3	2_Rx+	-	16	2_CTS+	-
4	2_Rx-	-	17	2_CTS-	-
5	2_GND	2_GND	18	-	-
6	-	-	19	-	-
7	-	-	20	-	-
8	-	-	21	-	-
9	1_Tx-	1_Data-	22	1_RTS-	-
10	1_Tx+	1_Data+	23	1_RTS+	-
11	1_Rx+	-	24	1_CTS+	-
12	1_Rx-	-	25	1_CTS-	-
13	1_GND	1_GND			

5.1.3 PCI-1603

The following table and figure shows the pin assignments of two male DB9 connectors on the bracket for PCI-1603 in RS-232 and current loop modes.

Table 5.4: PCI-1603 Male DB9 on bracket		
Pin	RS-232	Current Loop
1	DCD	TxD-
2	RxD	TxD+
3	TxD	RxD
4	DTR	RxD-
5	GND	-
6	DSR	-
7	RTS	-
8	CTS	-
10	RI	-

5.1.4 PCI-1604UP

The following tables and figures show the pin assignments of 1 female DB25 connector on the bracket to two male DB9 for PCI-1604UP card in RS-232 modes.

Table 5.5: PCI-1604UP Male DB9 on cable

Pin	RS-232
1	DCD
2	RxD
3	TxD
4	DTR
5	GND
6	DSR
7	RTS
8	CTS
9	RI

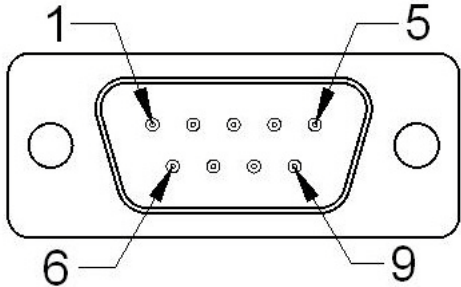

The diagram shows a top-down view of a male DB9 connector. It has a rectangular metal housing with a central 9-pin D-sub connector. Four pins are specifically labeled with arrows and numbers: pin 1 (top-left), pin 5 (top-right), pin 6 (bottom-left), and pin 9 (bottom-right). There are two circular mounting holes on the sides of the housing.

Table 5.6: PCI-1604UP Female DB25 on bracket

Pin	RS-232	Pin	RS-232
1	2_DCD	14	2_DSR
2	2_RxD	15	2_RTS
3	2_TxD	16	2_CTS
4	2_DTR	17	2_RI
5	GND	18	-
6	-	19	-
7	-	20	-
8	-	21	-
9	1_DCD	22	1_DSR
10	1_RxD	23	1_RTS
11	1_TxD	24	1_CTS
12	1_DTR	25	1_RI
13	GND		

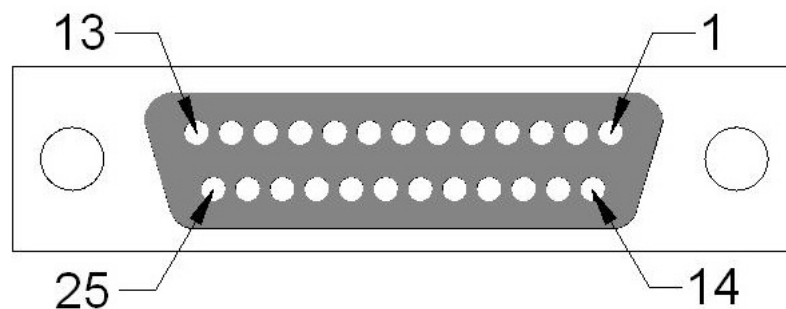

5.1.5 PCI-1610A/B/C

The following tables and figures show the pin assignments of 1 female DB37 connector on the bracket to male DB9/DB25 for PCI-1610A/B/C cards in RS-232 modes.

Table 5.7: PCI-1610A/B/C Male DB9 on cable

Pin	RS-232
1	DCD
2	RxD
3	TxD
4	DTR
5	GND
6	DSR
7	RTS
8	CTS
10	RI

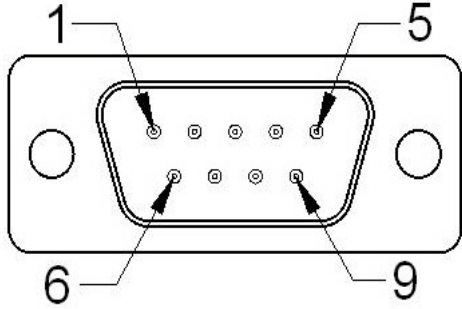

The diagram shows a top-down view of a male DB9 connector. It has a rectangular metal housing with a central 9-pin D-sub connector. Four pins are specifically labeled with arrows: pin 1 (top-left), pin 5 (top-right), pin 6 (bottom-left), and pin 9 (bottom-right). There are two circular mounting holes on the sides of the housing.

Table 5.8: PCI-1610A/B/C Male DB25 on cable

Pin	RS-232
2	TxD
3	RxD
4	RTS
5	CTS
6	DSR
7	GND
8	DCD
20	DTR
22	RI

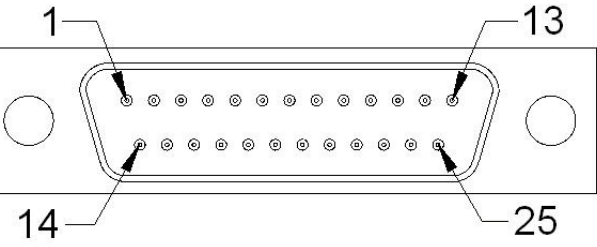

The diagram shows a top-down view of a male DB25 connector. It has a rectangular metal housing with a central 25-pin D-sub connector. Four pins are specifically labeled with arrows: pin 1 (top-left), pin 13 (top-right), pin 14 (bottom-left), and pin 25 (bottom-right). There are two circular mounting holes on the sides of the housing.

Table 5.9: PCI-1610A/B/C Female DB37 on bracket

Pin	RS-232	Pin	RS-232
1	-	20	3_RI
2	3_DCD	21	3_DTR
3	3_GND	22	3_DSR
4	3_CTS	23	3_RTS
5	3_RxD	24	3_TxD
6	4_RI	25	4_DCD
7	4_DTR	26	4_GND
8	4_DSR	27	4_CTS
9	4_RTS	28	4_RxD
10	4_TxD		
		29	2_RI
11	2_DCD	30	2_DTR
12	2_GND	31	2_DSR
13	2_CTS	32	2_RTS
14	2_RxD	33	2_TxD
15	1_RI	34	1_DCD
16	1_DTR	35	1_GND
17	1_DSR	36	1_CTS
18	1_RTS	37	1_RxD
19	1_TxD		

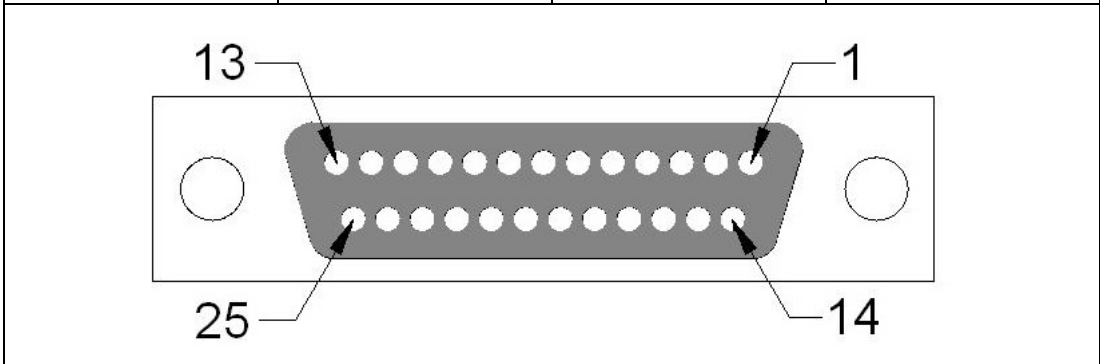

5.1.6 PCI-1612A/B/C

The following tables and figures show the pin assignments of 1 female DB37 connector on the bracket to male DB9/DB26 for the PCI-1612A/B/C cards in RS-232, RS-422 and RS-485 modes.

Table 5.10: PCI-1612A/B/C Male DB9 on cable

Pin	RS-232	RS-422	RS-485
1	DCD	Tx-	Data-
2	RxD	Tx+	Data+
3	TxD	Rx+	-
4	DTR	Rx-	-
5	GND	GND	GND
6	DSR	RTS-	-
7	RTS	RTS+	-
8	CTS	CTS+	-
10	RI	CTS-	-

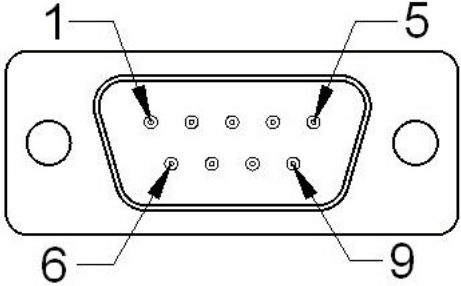

The diagram shows a top-down view of a male DB9 connector. It has a rectangular metal housing with a central 9-pin D-sub connector. Four pins are specifically labeled with arrows: pin 1 (top-left), pin 5 (top-right), pin 6 (bottom-left), and pin 9 (bottom-right). There are also two circular mounting holes on the sides of the housing.

Table 5.11: PCI-1612A/B/C Male DB25 on cable

Pin	RS-232	Pin	RS-232	Pin	RS-232
1	1_TxD	16	1_CTS	31	1_DCD
2	1_RxD	17	1_DTR	32	1_RI
3	1_RTS	18	1_DSR	33	1_GND
4	-	19	-	34	-
5	1_TxD	20	2_CTS	35	2_DCD
6	2_RxD	21	2_DTR	36	2_RI
7	2_RTS	22	2_DSR	37	2_GND
8	-	23	-	38	-
9	3_TxD	24	3_CTS	39	3_DCD
10	3_RxD	25	3_DTR	40	3_RI
11	3_RTS	26	3_DSR	41	3_GND
12	-	27	-		
13	4_TxD	28	4_CTS	42	4_DCD
14	4_RxD	29	4_DTR	43	4_RI
15	4_RTS	30	4_DSR	44	4_GND

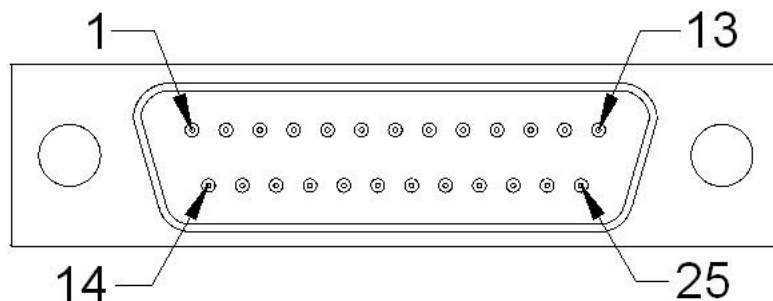
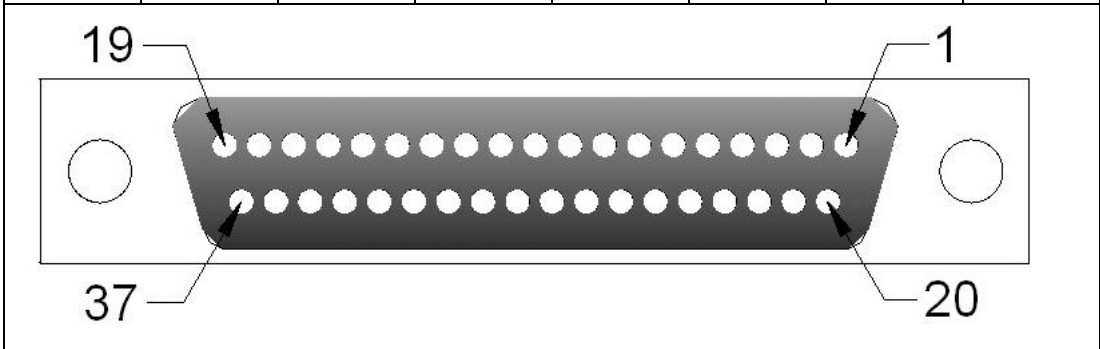

Table 5.12: PCI-1612A/B/C Female DB37 on bracket

Pin	RS-232	RS-422	RS-485	Pin	RS-232	RS-422	RS-485
1	-	-	-	20	3_RI	3_CTS-	-
2	3_DCD	3_TxD-	3_Data-	21	3_DTR	3_RxD-	-
3	3_GND	3_GND	3_GND	22	3_DSR	3_RTS-	-
4	3_CTS	3_CTS+	-	23	3_RTS	3_RTS+	-
5	3_RxD	3_TxD+	3_Data+	24	3_TxD	3_RxD+	-
6	4_RI	4_CTS-	-	25	4_DCD	4_TxD-	4_Data-
7	4_DTR	4_RxD	-	26	4_GND	4_GND	4_GND
8	4_DSR	4_RTS-	-	27	4_CTS	4_CTS+	-
9	4_RTS	4_RTS+	-	28	4_RxD	4_TxD+	4_Data+
10	4_TxD	4_RxD+	-				
				29	2_RI	2_CTS-	-
11	2_DCD	2_TxD-	2_Data-	30	2_DTR	2_RxD-	-
12	2_GND	2_GND	2_GND	31	2_DSR	2_RTS	-
13	2_CTS	2_CTS+		32	2_RTS	2_RTS+	-
14	2_RxD	2_TxD+	2_Data+	33	2_TxD	2_RxD+	-
15	1_RI	1_CTS-	-	34	1_DCD	1_TxD-	1_Data-
16	1_DTR	1_RxD	-	35	1_GND	1_GND	1_GND
17	1_DSR	1_RTS-	-	36	1_CTS	1_CTS+	-
18	1_RTS	1_RTS+	-	37	1_RxD	1_TxD+	1_Data+
19	1_TxD	1_RxD+	+				



5.1.7 PCI-1620A/B, PCIe-1620A/B and PCIe-1622A/B

The following tables and figures show the pin assignments of 1 female DB62 connector on the bracket to DB9/DB25 for the PCI-1620A/B and PCIe-1620A/B cards.

Table 5.13: PCI-1620A/B, PCIe-1620A/B and PCIe-1622A/B Female DB62 on bracket

Pin	RS-232	RS-422	RS-485	Pin	RS-232	RS-422	RS-485
1	1_TX	1_RX+	-	32	GND	GND	GND
2	1_DTR	1_RX-	-	33	5_TX	5_RX+	-
3	2_RX	2_TX+	2_D+	34	5_DTR	5_RX-	-
4	2_DSR	-	-	35	6_RX	6_TX+	6_D+
5	2_DCD	2_TX-	2_D-	36	6_DSR	-	-
6	3_TX	3_RX+	-	37	6_DCD	6_TX-	6_D-
7	3_DTR	3_RX	-	38	7_TX	7_RX+	-
8	4_RX	4_TX+	4_D+	39	7_DTR	7_RX-	-
9	4_DSR	-	-	40	GND	GND	GND
10	4_DCD	4_TX-	4_D-	41	8_TX	8_RX+	-
11	5_RX	5_TX+	5_D+	42	8_DTR	8_RX-	-
12	5_DSR	-	-	43	1_CTS	-	-
13	5_DCD	5_TX-	5_D-	44	1_RTS	-	-
14	6_TX	6_RX+	-	45	GND	GND	GND
15	6_DTR	6_RX-	-	46	2_CTS	-	-
16	7_RX	7_TX+	7_D+	47	2_RTS	-	-
17	7_DSR	-	-	48	3_CTS	-	-
18	7_DCD	7_TX-	7_D-	49	3_RTS	-	-
19	8_RX	8_TX+	8_D+	50	GND	GND	GND
20	8_DSR	-	-	51	4_CTS	-	-
21	8_DCD	8_TX-	8_D-	52	4_RTS	-	-
22	1_RX	1_TX-	1_D+	53	5_CTS	-	-
23	1_DSR	-	-	54	5_RTS	-	-
24	1_DCD	1_TX-	1_D-	55	GND	GND	GND
25	2_TX	2_RX+	-	56	6_CTS	-	-
26	2_DTR	2_RX-	-	57	6_RTS	-	-
27	3_RX	3_TX+	3_D+	58	GND	GND	GND
28	3_DSR	-	-	59	7_CTS	-	-
29	3_DCD	3_TX-	3_D-	60	7_RTS	-	-
30	4_TX	4_RX+	-	61	8_CTS	-	-
31	4_DTR	4_RX-	-	62	8_RTS	-	-

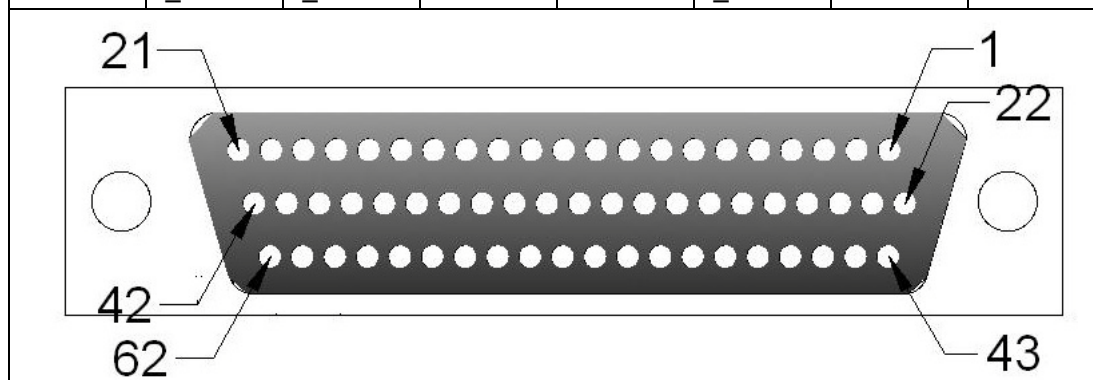

Table 5.14: PCI-1620A/B/C, PCIe-1620A/B, and PCIe-1622A/B Male DB9 on cable

Pin	RS-232	RS-422	RS-485
1	DCD	TX-	D-
2	RxD	TX+	D+
3	TxD	RX+	-
4	DTR	RX-	-
5	GND	GND	GND
6	DSR	-	-
7	RTS	-	-
8	CTS	-	-

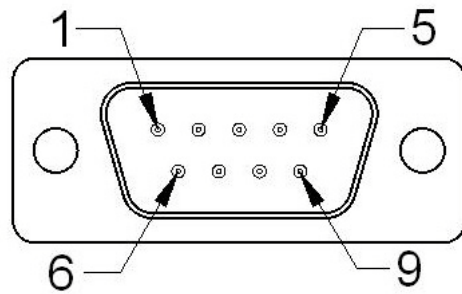
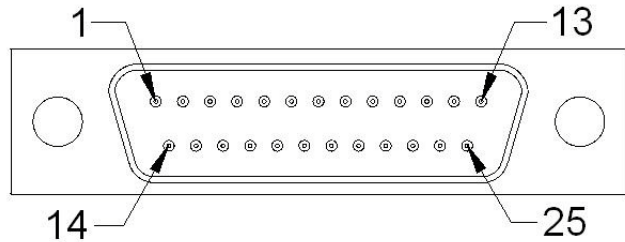

Table 5.15: PCI-1620A/B/C, PCIe-1620A/B, and PCIe-1622A/B Male DB25 on cable

Pin	RS-232	RS-422	RS-485
1	-	TX-	D-
2	TxD	TX+	D+
3	RxD	RX+	-
4	RTS	RX-	-
5	CTS	GND	GND
6	DSR	-	-
7	GND	-	-
8	DCD	-	-
20	DTR	-	-



5.1.8 PCI-1622B/C

The following table and figure show the pin assignments of 1 female DB78 connector on the bracket to DB9/DB25 for the PCI-1622B/C cards in RS-422 and RS-485 modes.

Table 5.16: PCI-1622B/C Male DB9 on cable

Pin	RS-422	RS-485
1	TxD-	Data-
2	TxD+	Data+
3	RxD+	-
4	RxD-	-
5	GND	GND
6	RTS-	-
7	RTS+	-
8	CTS+	-
9	CTS-	-

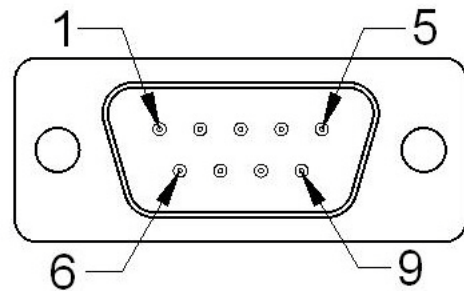

Table 5.17: PCI-1622B/C Female DB78 on bracket					
Pin	RS-422	RS-485	Pin	RS-422	RS-485
1	8_GND	8_GND	40	8_TxD-	8_Data-
2	8_RTS-	-	41	8_TxD+	8_Data+
3	8_RTS+	-	42	7_GND	7_GND
4	7_RTS-	-	43	7_TxD-	7_Data-
5	7_RTS+	-	44	7_TxD+	7_Data+
6	6_RTS-	-	45	6_TxD-	6_Data-
7	6_RTS+	-	46	6_TxD+	6_Data+
8	-	-	47	5_GND	5_GND
9	5_RTS-	-	48	5_TxD-	5_Data-
10	5_RTS+	-	49	5_TxD+	5_Data+
11	4_RTS-	-	50	4_TxD-	4_Data-
12	4_RTS+	-	51	4_TxD+	4_Data+
13	-	-	52	3_GND	3_GND
14	3_RTS-	-	53	3_TxD-	3_Data-
15	3_RTS+	-	54	3_TxD+	3_Data+
16	2_RTS-	-	55	2_TxD-	2_Data-
17	2_RTS+	-	56	2_TxD+	2_Data+
18	-	-	57	1_GND	1_GND
19	1_RTS-	-	58	1_TxD-	1_Data-
20	1_RTS+	-	59	1_TxD+	1_Data+
21	8_CTS+	-	60	8_RxD+	-
22	8_CTS-	-	61	8_RxD-	-
23	7_CTS+	-	62	7_RxD+	-
24	7_CTS-	-	63	7_RxD-	-
25	-	-	64	6_GND	6_GND
26	6_CTS+	-	65	6_RxD+	-
27	6_CTS-	-	66	6_RxD-	-
28	5_CTS+	-	67	5_RxD+	-
29	5_CTS-	-	68	5_RxD-	-
30	-	-	69	4_GND	4_GND
31	4_CTS+	-	70	4_RxD+	-
32	4_CTS-	-	71	4_RxD-	-
33	3_CTS+	-	72	3_RxD+	-
34	3_CTS-	-	73	3_RxD-	-
35	-	-	74	2_GND	2_GND
36	2_CTS+	-	75	2_RxD+	-
37	2_CTS-	-	76	2_RxD-	-
38	1_CTS+	-	77	1_RxD+	-
39	1_CTS-	-	78	1_RxD-	-

5.2 Wiring

5.2.1 5.2.1 RS-232 Signal Wiring

Since the RS-232 interface is not strictly defined, many devices have their own connection methods which may ignore some signal lines or define reserved lines for other functions. It is best to refer to the user's manual for your device for installation instructions. You may find the following helpful.

In general, DTE (Data Terminal Equipment) refers to the device that is leading the communication. Examples include PC's, terminals and some printers. DCE refers to the device being communicated with or controlled. Examples include modems, DSU's (digital service units), printers and lab/factory equipment.

In some situations you may be able to get by with just three lines: data on TXD, a signal ground and a handshaking line. Examples are printer or plotter connections, troubleshooting and situations where you require only one-wire communication.

Table 5.18: Terminal or PC (DTE) Connections

DB-25 Male		DB-25 Male or Female: Terminal	
Pin	Signal	Pin	Signal
2	TxD	3	RxD
3	RxD	2	TxD
4	RTS	5	CTS
5	CTS	4	RTS
6	DSR	20	DTR
7	GND	7	GND
20	DTR	6	DSR
8	DCD	8	DCD

Table 5.19: Modem Connections

DB-25 Male		Modem (DCE)	
Pin	Signal	Pin	Signal
2	TxD	3	RxD
3	RxD	2	TxD
4	RTS	5	CTS
5	CTS	4	RTS
6	DSR	20	DTR
7	GND	7	GND
20	DTR	6	DSR
8	DCD	8	DCD

For DTE to DCE connections, use a straight through cable (i.e., you don't have to reverse lines 2 and 3, lines 4 and 5, and lines 6 and 20 since, in general, the DCE RS-232 interfaces are reversed themselves).

Table 5.20: Terminal without Handshake			
DB-25 Male		Terminal, PC (DTE)	
Pin	Signal	Pin	Signal
2	TxD	3	RxD
3	RxD	2	TxD
4	RTS		
5	CTS		
7	GND	7	GND
6	DSR		
20	DTR		
8	DCD		

Therefore, if you are not using CTS, RTS, DSR, DTR and DCD signals, short pins 4 and 5 together, and please short pins 6, 8, and 20 together.

5.2.2 RS-422 Signal Wiring

The RS-422 interface wiring is based on one-to-one principles. The transmit lines on one side connect to the receive lines on the other side, and vice versa. With RS-422, you can transmit and receive data simultaneously (full duplex). The connections are as follows:

Table 5.21: RS-422 DB9 Pin Assignment			
DTE (Male DB-9)		Terminal DTE	
Pin	Signal	Pin	Signal
1	TxD-	1	RxD-
2	TxD+	2	RxD+
3	RxD+	3	TxD+
4	RxD-	4	TxD-
5	GND	5	GND
6	RTS-	6	CTS-
7	RTS+	7	CTS+
8	CTS+	8	CTS+

Terminator Resistors Setup

The signals DSR, DTR and DCD are shorted internally on the PCI-1601/1602/1611/1612/1622 cards when operating in RS-422 mode.

A user can solder in termination resistors if necessary for impedance matching. The card has two mounting spaces for termination resistors, but no resistors are installed at the factory. Each pair of signal lines has a separate resistor (RxD+/-, TxD+/-).

5.2.3 RS-485 Signal Wiring

The RS-485 standard supports half-duplex communication. This means that just two wires are needed to both transmit and receive data. Handshaking signals (such as RTS, Request To Send) are normally used to control the direction of the data flow and to switch the transmission accordingly. In RS-485 mode, the PCI-1601/1602/1611/1612/1622 cards automatically sense the direction of the data flow and switch the transmission direction — no handshaking is necessary. This means a user can build an RS-485 network with just two wires. This RS-485 control is completely transparent to the user. The software written for half duplex RS-232 works without any modification.

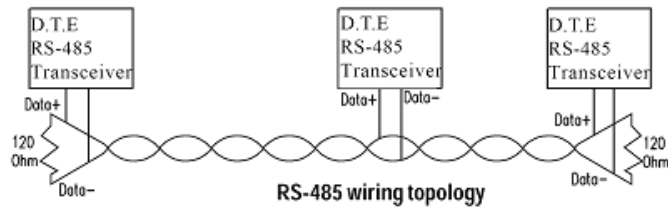

Figure 5.1 RS-485 Wiring Topology

Termination Resistor Setup

You can install termination resistors if necessary for impedance matching. The card has mounting spaces for termination resistors, but no resistors are installed at the factory. Depending on your application you may need to solder in a single resistor to handle the DATA+/DATA- pair (**and a corresponding resistor on the other end of the connection**). The value of the resistor should equal the characteristic impedance of the signal wires (approximately 120 Ohms or 300 Ohms).

Appendix **A**

Scale of Connectors

A.1 Connector Size Comparison

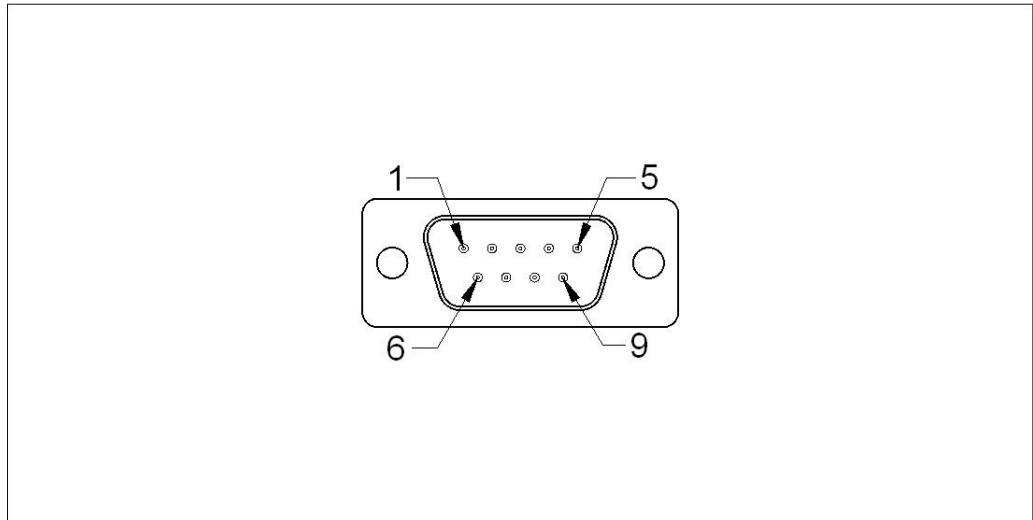

Figure A.1 DB9 Male

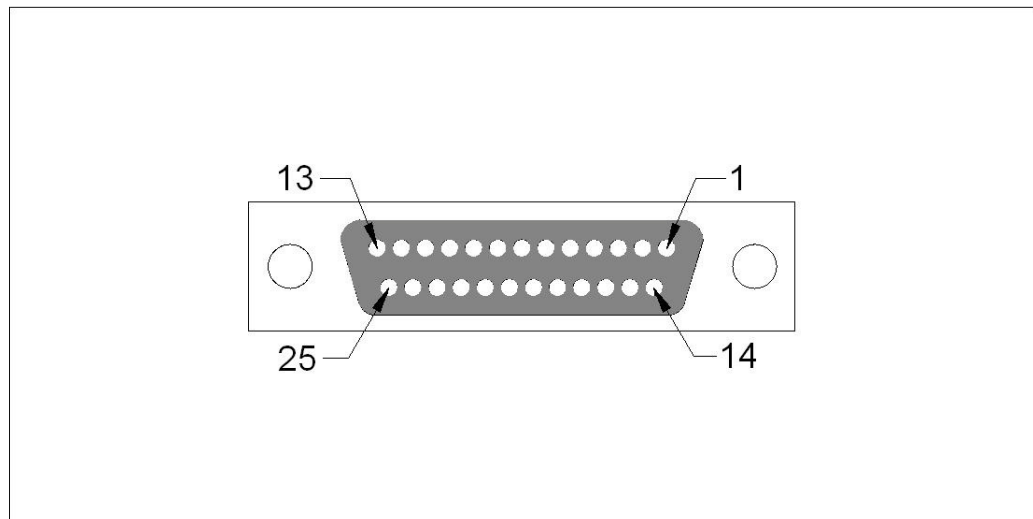

Figure A.2 DB25 Female

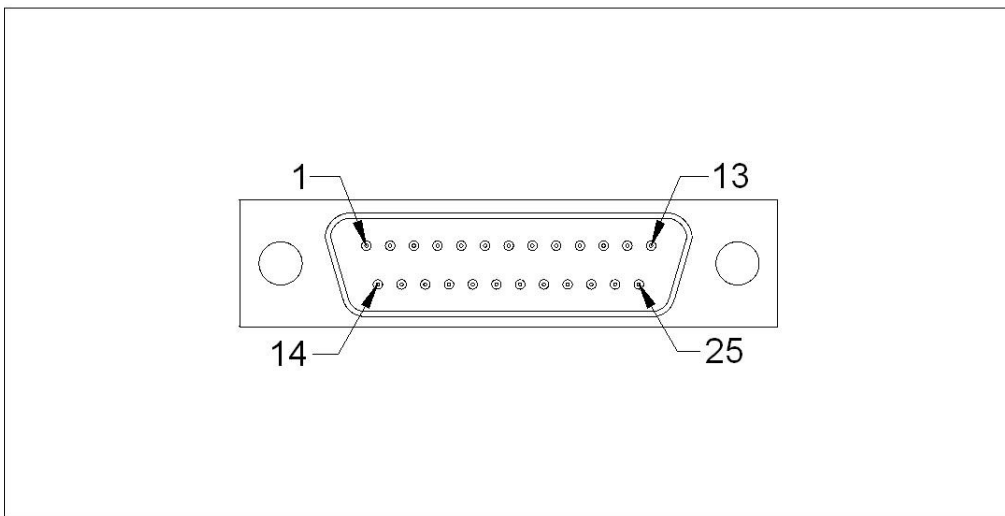

Figure A.3 DB25 Male

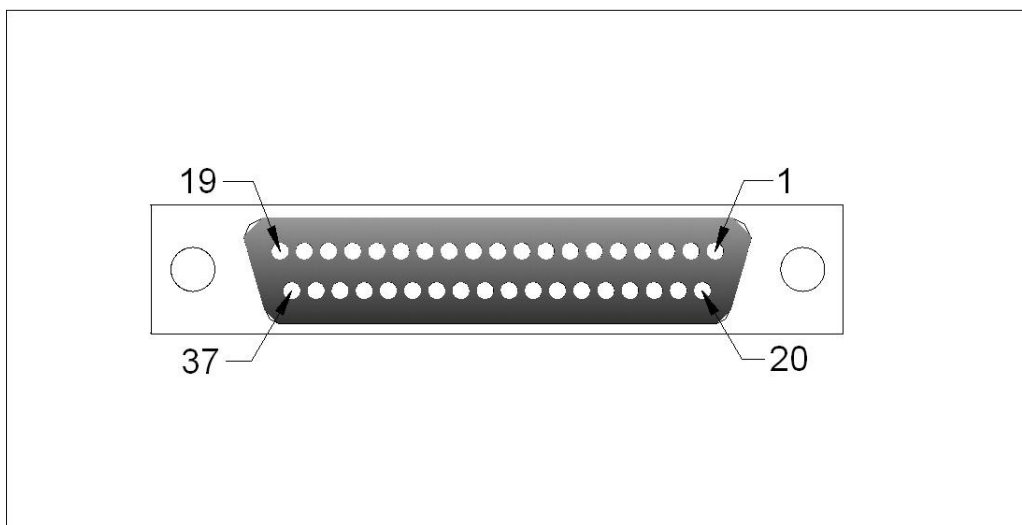

Figure A.4 DB37 Female

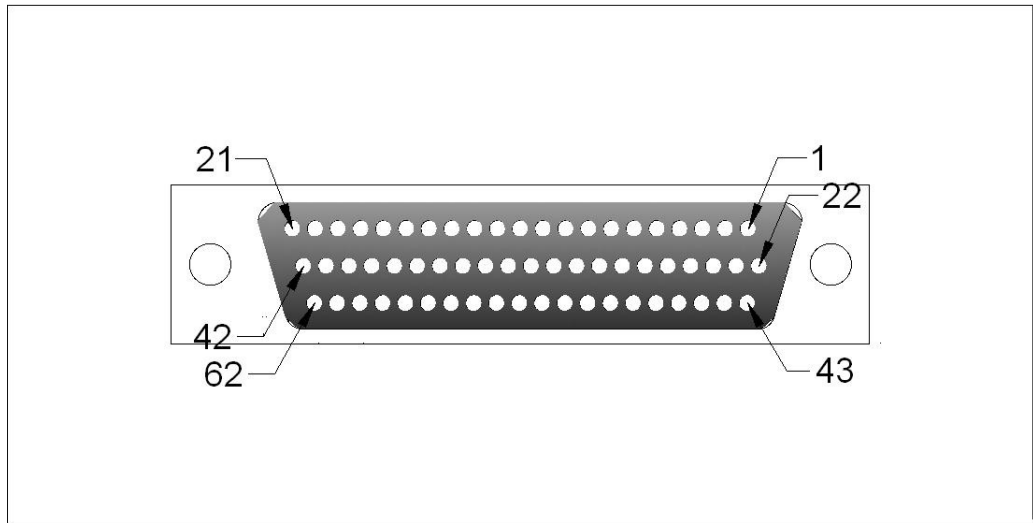

Figure A.5 DB62 Female

ADVANTECH

Enabling an Intelligent Planet

www.advantech.com

Please verify specifications before quoting. This guide is intended for reference purposes only.

All product specifications are subject to change without notice.

No part of this publication may be reproduced in any form or by any means, electronic, photocopying, recording or otherwise, without prior written permission of the publisher.

All brand and product names are trademarks or registered trademarks of their respective companies.

© Advantech Co., Ltd. 2014