



I-7188E2/I-7188E2D

Programmable Ethernet to 2x serial ports converter

Features

- Incorporates any RS-232/485 serial device in Ethernet
- Data transmission via Virtual COM or raw TCP connection
- VxComm Driver for 32-bit and 64-bit Windows XP/2003/2008/Vista/7/8/10
- Built-in High-Performance MiniOS7 from ICP DAS
- Watchdog Timer suitable for use in harsh environments
- Palm-Sized with multiple Serial Ports
- Power Reverse Polarity Protection



Introduction

The I-7188EN series is a family of Programmable Device Servers, also known as "Serial-to-Ethernet gateway", that are designed for linking RS-232/422/485 devices to an Ethernet network. The user-friendly VxComm Driver/Utility allows users to easily turn the built-in COM ports of the I-7188EN series into standard COM ports on a computer. By virtue of its protocol independence, a small-core OS and high flexibility, the I-7188EN series is able to meet the demands of every network-enabled application.

The I-7188EN series includes a powerful and reliable Xserver programming structure that allows you to design your robust Ethernet applications in one day. The built-in high-performance MiniOS7 boots the I-7188EN up in just one second and gives you the fastest responses.

The I-7188E2(D) is equipped with 1 RS-232 port and 1 RS-485 port. The removable on-board terminal block connector is designed for easy and robust wiring in industrial situations.

Apparances

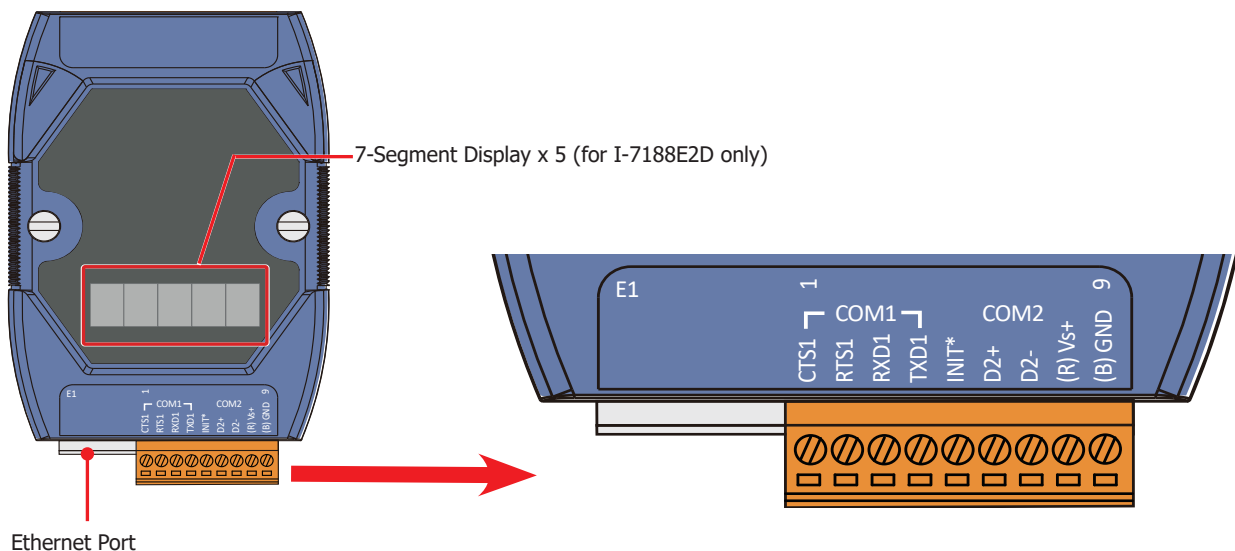

Specifications

Models	I-7188E2	I-7188E2D
CPU Module		
CPU	80188, 40MHz or compatible	
SRAM	384 KB	
Flash	512 KB	
EEPROM	2 KB	
Watchdog Timer	0.8 second	
Communication Interface		
COM1	RS-232 (TXD, RXD, RTS, CTS, GND)	
COM2	RS-485 (D+, D-)	
Ethernet Port	10BASE-T NE2000 compatible Ethernet Controller	
COM Port Format		
Data Bit	7, 8	
Parity	Even, Odd, None	
Stop Bit	1	
Baud Rate	115200 bps Max.	
LED Indicator		
7-Segment Display	-	Yes
System LED Indicator	Yes	
Mechanical		
Dimensions (W x L x H)	113 mm x 72 mm x 3 mm	
Operating Environment		
Operating Temperature	-25 °C to +75 °C	
Storage Temperature	-40 °C to +80 °C	
Humidity	5 to 95 %,non-condensing	
Power		
Protection	Power reverse polarity protection	
Power requirement	10 to 30 VDC	
Power consumption	2 W	3 W

■ Dimensions (Units: mm)

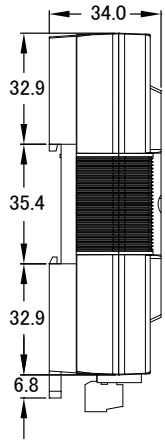

Left Side View

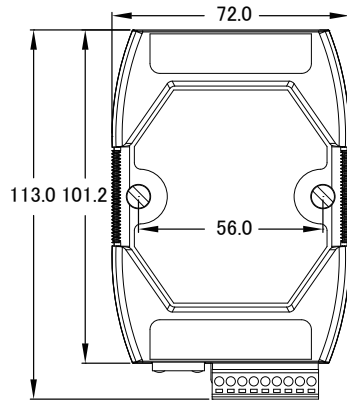

Front View

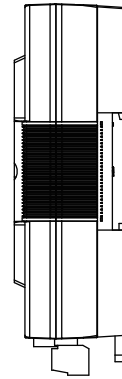

Right Side View

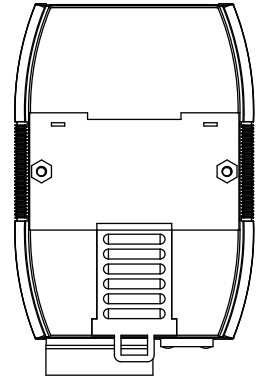



Rear View

■ Ordering Information

I-7188E2 CR	Programmable Ethernet to 2x serial ports converter (1x RS-232, 1x RS-485) (RoHS)
I-7188E2D CR	Programmable Ethernet to 2x serial ports converter (1x RS-232, 1x RS-485) with LED display (RoHS)

■ Accessories

 MDR-20-24 CR	24 VDC/2.5 A, 60 W Power Supply with DIN-Rail Mounting (RoHS)
 GPSU06U-6 CR	Power Supply, 110~240VAC or 127~230VDC to 24VDC/0.25A, 6 W, two pins USA plug (RoHS)